

ACER PREDATOR G3620 SERVICE MANUAL



Quick Links

[Reinstalling Main Board](#)

[BIOS Recovery](#)

[Internal Header Pin Definition](#)

Table of Contents

revision history

fru information

Table of Contents

Features

- hard disk drive

- optical disk drive

- graphics card

- serial ata controller

- system bios

- power supply

Block Diagram

System Components

- Front Panel

- Rear Panel

Hardware Specifications and Configurations

- memory combinations

- system memory

- sata interface

- usb port

- audio interface

- environmental requirements

- power management

Power Management Function(ACPI support function)

CMOS Setup Utility

- Entering CMOS setup

- Navigating Through the Setup Utility

Setup Utility Menus

- advanced chipset configuration
- integrated peripherals
- pc health status
- boot options

Disassembly Requirements

Pre-disassembly Procedure

- Removing the Side Panel
- Removing the Front Bezel
- Removing the Heat Sink Fan Assembly
- Removing the Processor
- Removing the VGA Card
- Removing the Wireless Lan Card
- Removing the Modem Card
- Removing the Memory Modules
- Removing the Hard Disk Drive
- Removing the Bracket of Removable HDD
- Removing the Optical Drive
- Removing the System Fan
- Removing the Power Supply
- Removing the Mainboard
- Removing the Top Cover
- Removing the Top USB and Audio I/O Assembly
- Removing the Card Reader

Assembly Requirements

Assembly Procedure

- Removing the Side Panel
- Removing the Cage of Hard Disk Drive
- Removing the Bracket of Removable HDD

- Removing the PCI Cover
- Reinstalling the Power Supply
- Reinstalling the I/O Shielding
- Reinstalling the MainBoard
- Reinstalling the Optical Drive
- Reinstalling the Bracket of Removable HDD
- Reinstalling the Hard Disk Drive
- Reinstalling the System Fan
- Reinstalling the Memory
- Reinstalling the Processor
- Reinstalling the Heat Sink Fan Assembly
- Reinstalling the Modem Card
- Reinstalling the Wireless Lan Card
- Reinstalling the VGA Card
- Reinstalling the Front Bezel
- Install the Side Panel

Hardware Diagnostic Procedure

System Check Procedures

- Power System Check
- System External Inspection
- System Internal Inspection

Beep Codes

Checkpoints

bootblock recovery code checkpoints

BIOS Recovery

M/B Placement

Jumper Setting

Internal header pin definition

[Connector pin definition](#)

[Predator G3620 Exploded Diagram](#)

[Predator G3620 FRU List](#)

Acer

**Predator G3620
Service Guide**

PRINTED IN TAIWAN

Revision History

Please refer to the table below for the updates made on this service guide.

Date	Chapter	Updates

Copyright

Copyright © 2012 by Acer Incorporated. All rights reserved. No part of this publication may be reproduced, transmitted, transcribed, stored in a retrieval system, or translated into any language or computer language, in any form or by any means, electronic, mechanical, magnetic, optical, chemical, manual or otherwise, without the prior written permission of Acer Incorporated.

Disclaimer

The information in this guide is subject to change without notice.

Acer Incorporated makes no representations or warranties, either expressed or implied, with respect to the contents hereof and specifically disclaims any warranties of merchantability or fitness for any particular purpose. Any Acer Incorporated software described in this manual is sold or licensed "as is". Should the programs prove defective following their purchase, the buyer (and not Acer Incorporated, its distributor, or its dealer) assumes the entire cost of all necessary servicing, repair, and any incidental or consequential damages resulting from any defect in the software.

Acer is a registered trademark of Acer Corporation.

Intel is a registered trademark of Intel Corporation.

Pentium Dual-Core, Celeron Dual-Core, Core 2 Duo, Core 2 Quad, Celeron, and combinations thereof, are trademarks of Intel Corporation.

Other brand and product names are trademarks and/or registered trademarks of their respective holders.

Conventions

The following conventions are used in this manual:

SCREEN MESSAGES	Denotes actual messages that appear on screen.
NOTE	Gives additional information related to the current topic.
WARNING	Alerts you to any physical risk or system damage that might result from doing or not doing specific actions.
CAUTION	Gives precautionary measures to avoid possible hardware or software problems.
IMPORTANT	Reminds you to do specific actions relevant to the accomplishment of procedures.

Service Guide Coverage

This Service Guide provides you with all technical information relating to the BASIC CONFIGURATION decided for Acer's "global" product offering. To better fit local market requirements and enhance product competitiveness, your regional office MAY have decided to extend the functionality of a machine (e.g. add-on card, modem, or extra memory capability). These LOCALIZED FEATURES will NOT be covered in this generic service guide. In such cases, please contact your regional offices or the responsible personnel/channel to provide you with further technical details.

FRU Information

Please note WHEN ORDERING FRU PARTS, that you should check the most up-to-date information available on your regional web or channel. If, for whatever reason, a part number change is made, it will not be noted in the printed Service Guide. For ACER-AUTHORIZED SERVICE PROVIDERS, your Acer office may have a DIFFERENT part number code to those given in the FRU list of this printed Service Guide. You MUST use the list provided by your regional Acer office to order FRU parts for repair and service of customer machines.

Table of Contents

System Tour	1
Features	1
Block Diagram	5
System Components	6
Front Panel	6
Rear Panel	7
Hardware Specifications and Configurations	8
Power Management Function(ACPI support function)	12
System Utilities	13
CMOS Setup Utility	13
Entering CMOS setup	14
Navigating Through the Setup Utility	14
Setup Utility Menus	15
System Disassembly and Assembly	25
Disassembly Requirements	25
Pre-disassembly Procedure	26
Removing the Side Panel	27
Removing the Front Bezel	28
Removing the Heat Sink Fan Assembly	29
Removing the Processor	31
Removing the VGA Card	33
Removing the Wireless Lan Card	35
Removing the Modem Card	36
Removing the Memory Modules	37
Removing the Hard Disk Drive	38
Removing the Bracket of Removable HDD	41
Removing the Optical Drive	42
Removing the System Fan	44
Removing the Power Supply	46
Removing the Mainboard	48
Removing the Top Cover	51
Removing the Top USB and Audio I/O Assembly	53
Removing the Card Reader	54
Assembly Requirements	55
Assembly Procedure	56
Removing the Side Panel	57
Removing the Cage of Hard Disk Drive	58
Removing the Bracket of Removable HDD	59
Removing the PCI Cover	60
Reinstalling the Power Supply	61
Reinstalling the I/O Shielding	62
Reinstalling the Main Board	63
Reinstalling the Optical Drive	65
Reinstalling the Bracket of Removable HDD	67
Reinstalling the Hard Disk Drive	68
Reinstalling the System Fan	72
Reinstalling the Memory	73
Reinstalling the Processor	74
Reinstalling the Heat Sink Fan Assembly	76
Reinstalling the Modem Card	78

Reinstalling the Wireless Lan Card	79
Reinstalling the VGA Card	80
Reinstalling the Front Bezel	82
Install the Side Panel	83
System Troubleshooting	84
Hardware Diagnostic Procedure	84
System Check Procedures	85
Power System Check	85
System External Inspection	85
System Internal Inspection	85
Beep Codes	86
Checkpoints	87
BIOS Recovery	90
Jumper and Connector Information	93
M/B Placement	93
Jumper Setting	95
Internal header pin definition	98
Connector pin definition	101
FRU (Field Replaceable Unit) List	106
Predator G3620 Exploded Diagram	107
Predator G3620 FRU List	109

System Tour

Features

Below is a brief summary of the computer's many features:

NOTE: The features listed in this section are for your reference only. The exact configuration of the system depends on the model purchased.

Operating System

- Microsoft Windows 7 Home Premium x64
- Microsoft Windows 7 Home Basic x64
- Microsoft Windows 7 Home Premium x86
- Microsoft Windows 7 Home Basic x86
- Microsoft Windows 7 Starter x86
- Linpus XWindows
- Free DOS

Processor

- Intel Ivy Bridge / Sandy Bridge Processor includes unlock K SKU CPU.
- Socket type: LGA1155.
- FMB: 65W / 95W and support K sku OC need support 130w power design.

Chipset

- PCH: Intel B75

PCB

- uATX, max 4 Layers

Memory subsystem

- 2 channels, 2 DIMMs per channel. Different colors for DIMM 0 and DIMM 1.
- Dual channel should be enabled always when plug-in 2 same memory size DDR3 memory module.
- DDR3 * 4.
- Max memory of 16 GB supported (using 4Gb tech).
- Support DDR3 1.5V 1333/1600 (1GB / 2GB / 4GB).

Graphics

- Intel® HD Graphics Support (supported by CPU).
 - Dual independent display.
 - Digital display (HDMI/DVI/DP/eDP) and VGA.
 - DVMT 5.0 technology support.
 - Enhanced 3D and Clear Video technology support.
 - Need to measure VGA follow Acer VGA SOP.
- Monitor compatible is requested to the monitor AVL and DQM recommended list.

Hard disk drive

- Support up to three SATA ports.
- 3.5",25.4mm.
- Capacity and models are listed on AVLC.

Optical disk drive

- Support one SATA 5.25" standard ODD.
- Support DVD-ROM, DVD-SuperMulti, BD-combo, BD-rewrite.
- Maximum ODD depth to 185mm with bezel.
- Models are listed on AVLC.

Graphics card

- No mechanical restriction to support dual slot, full length graphics cards in the single PCIe X16 slot.
- Please make sure there is no component conflict with PCIe card. Especially VGA card, we may have double width card support.

Audio

- Realtek ALC662VD.
- Rear IO: 3 jack.
- Front IO: 1*Microphone-in, 1*head phone jack.

Serial ATA controller

- SATA * 6 (different color to identify SATA 6Gb/s and SATA 3Gb/s).
- 1 * SATA 6 Gb/s and 5 * SATA 3Gb/s .
- HDD : AHCI/Native IDE is required.
- ODD: Support BD/SuperMulti/DVD ROM.

LAN

- Giga Lan, Intel 82579V co-lay with Realtek LAN 8111E.

SUPER IO

- Support PECI 3.0 and detect VRD/CPU/System temperature.
- ITE 8772E or other solution proposed by MB vender.

Extension slot

- 1 * PCIE x16 (PCIE V3.0)
- 3 * PCIE x1 (PCIE V2.0)

USB2.0

- Rear IO : * 4 ports.
- Internal Header: *4 ports (2 * USB2.0 H5X2 Header).
- All ports should meet USB IF spec and support 1A current over drive.

USB3.0

- Rear IO: * 2 ports.
- Internal Header: *4 ports (2 * USB2.0 H5X2 Header).
- All ports should meet USB IF spec and support 1A current over drive.
- Upper port should reserve 1.5A charger when power state at S3/S4/S5. The charger port should be compatible with Apple and non-Apple device.
- Charger IC is required and support Apple and non-Apple devices. ODM proposed.

Buzzer

- 1 on board buzzer.

Rear I/O connectors

- 1 * PS2 KB+MS
- 1 * VGA connector
- 1 * HDMI
- 1 * RJ45 + Dual USB2.0(p.s. surge for China only)
- 1 * Dual USB2.0 connector
- 2 * USB 3.0 stack
- 1 * 3 ports Audio jack
- 1* COM port for China only (option)

On-board connectors

- 1 * ILM(Independent Loading Mechanism) for LGA 1155 CPU (assign by Acer).
- 1 * 24-pin ATX PWR connector.
- 1 * H2X4 Power Supply Connector.
- 4 * DDR3 DIMM Socket.
- 5 * SATA 3Gb/s.
- 1 * SATA 6Gb/s.
- 2 * USB2.0 H5X2 Header (support 4 ports).
- 1 * USB 3.0 H10x2 Header (support 2 ports). Location is defined in EE requirement.
- 1 * Front Audio Pannel H5X2 header.
- 1 * Front Panel IO H7X2 Header for Acer pin define.
- 1 * H1X4 CPU with SAMRT FAN controller.
- 1 * H1X3 System with SAMRT FAN controller.
- 1 * H3X1 Clear CMOS Header (with jumper).
- 1 * onboard Buzzer.
- 2 * H1X2 GPIO header.
- 1 * H10X2 TPM header.
- 1 * H1X2 System power to support 4A current at power state S0/S1.
- 1 * 3pin ME enable / disable connector (Jumper).

System BIOS

- Type: Use SPI Flash
- System BIOS: 8MB
- Kernel: AMI Kernel with Acer skin

Power supply

- Non PFC 300W / PFC 300W /FR 300W.
- Support models are listed on AVLC.

Block Diagram

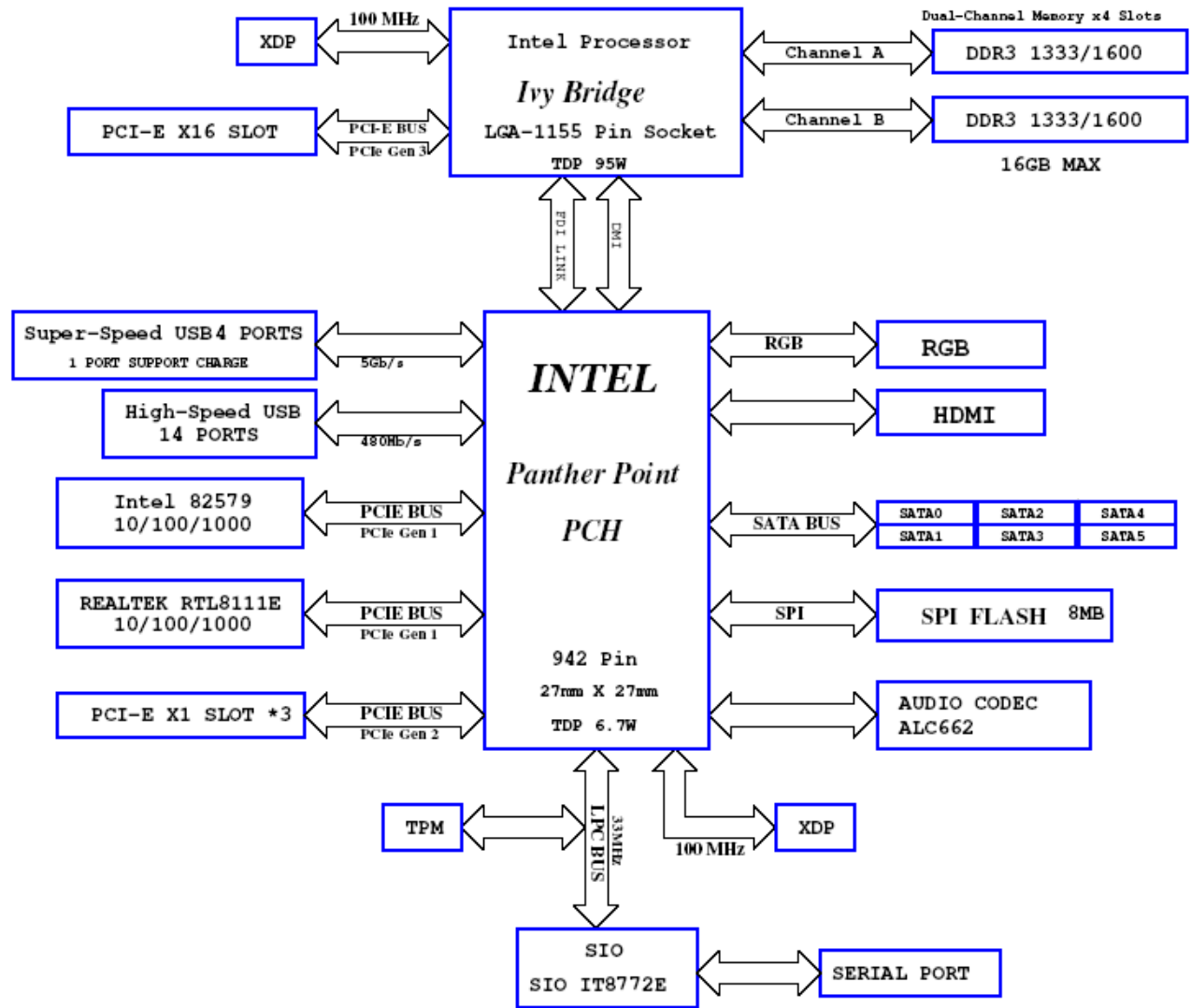

System Components

This section is a virtual tour of the system's interior and exterior components.

Front Panel

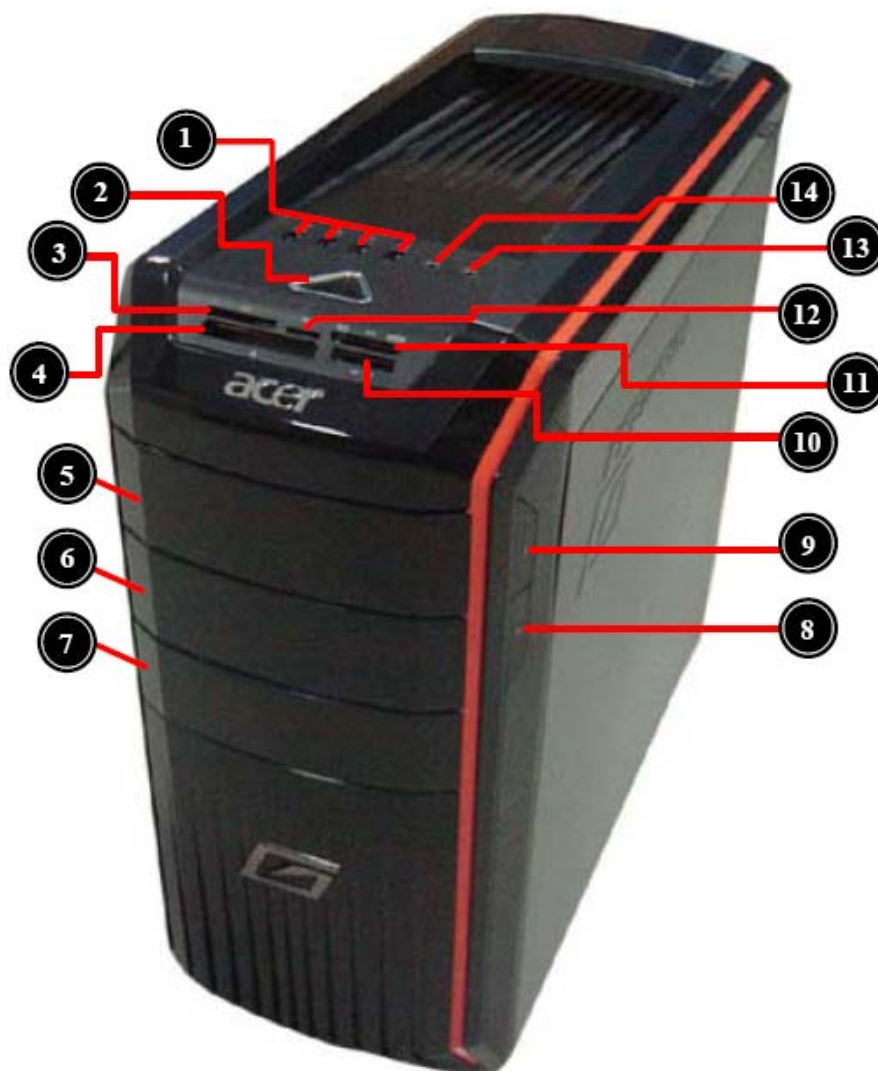

No.	Component		
1	USB 2.0 ports	8	Slave optical drive button
2	Power button	9	Master optical drive button
3	XD(XD-Picture) slot	10	MS/MS PRO slot
4	CF I/II (CompactFlash Type I/II) slot	11	SD/MMC(Secure Digital/MultiMedia Card)slot
5	Master optical drive	12	Micro SD slot
6	Slave optical drive	13	Microphone-in jack
7	Removable HDD bay(Removable HDD bay for XXX bezel)	14	Headphone/Speaker-out/line-out jack

Rear Panel

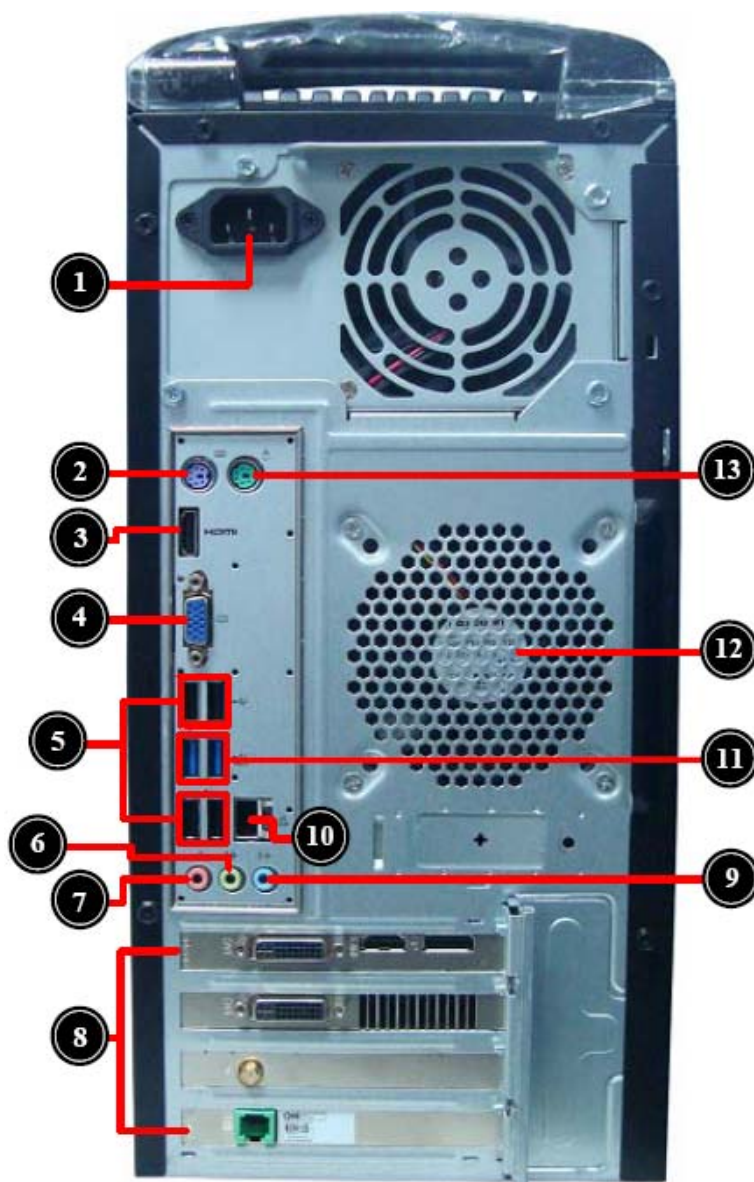

No.	Component
1	Power connector
2	PS2 keyboard port
3	HDMI port
4	VGA port
5	USB 2.0 ports
6	Line-out jack
7	Microphone-in jack
8	Expansion slot (Modem card and Graphics card)
9	line-in jack
10	RJ45 LAN connector
11	USB 3.0 ports
12	System FAN
13	PS2 mouse port

Hardware Specifications and Configurations

Processor

Item	Specification
Processor Type	Intel Ivy Bridge / Sandy Bridge Processor includes unlock K SKU CPU
Socket Type	LGA1155
Minimum operating speed	0 MHz (If Stop CPU Clock in Sleep State in BIOS Setup is set to Enabled.)

BIOS

Item	Specification
BIOS code programmer	AMI Kernel with Acer skin
BIOS version	P01-A0
BIOS ROM type	SPI Flash
BIOS ROM size	8Mb
Support protocol	SMBIOS(DMI)2.4/DMI2.0
Device Boot Support	1st priority: SATA HDD 2nd priority: CD-ROM 3rd priority: Removable Device 4th priority: LAN 5th priority: USB device
Support to LS-120 drive	YES
Support to BIOS boot block feature	YES

BIOS Hotkey List

Hotkey	Function	Description
Del	Enter BIOS Setup Utility	Press while the system is booting to enter BIOS Setup Utility.

Main Board Major Chips

Item	Specification
Chipset	Intel B75
USB controller	Intel B75
Audio controller	Realtek ALC662VD
LAN controller	Intel 82579LM
SATA controller	Intel B75
Super IO controller	ITE 8772E

Memory Combinations

Slot	Memory	Total Memory
Slot 1	1GB,2GB,4GB	1G ~4GB
Slot 2	1GB,2GB,4GB	1G ~4GB
Slot 3	1GB,2GB,4GB	1G ~4GB
Slot 4	1GB,2GB,4GB	1G ~4GB
Maximum System Memory Supported		1G~16GB

System Memory

Item	Specification
Memory slot number	4 slot
Support Memory size per socket	1GB/2GB/4GB
Support memory type	DDRIII
Support memory interface	DDRIII 1333/1600MHz
Support memory voltage	1.5V
Support memory module package	240-pin DDRIII
Support to parity check feature	Yes
Support to error correction code (ECC) feature	No
Memory module combinations	You can install memory modules in any combination as long as they match the above specifications.

SATA Interface

Item	Specification
SATA controller	Intel B75
Number of SATA channel	SATA X 6(1 * SATA 6 Gb/s and 5 * SATA 3Gb/s)
Support mode	HDD : AHCI/Native IDE is required. ODD: Support BD/SuperMulti/DVD ROM.

USB Port

Item	Specification
Universal HCI	USB 2.0/1.1 or USB 3.0
USB Class	Support legacy keyboard for legacy mode
USB Connectors Quantity	USB2.0: <ul style="list-style-type: none"> Rear IO : * 4 ports, Internal Header: *4 ports (2 * USB2.0 H5X2 Header). USB3.0: <ul style="list-style-type: none"> Rear IO: * 2 ports, Internal Header: * 2 ports(10x2 header).

Audio Interface

Item	Specification
Audio controller	Intel PCH Panther Point B75
Audio controller type	REALTEK/ALC662-VD0-GR
Audio channel	codec 5.1
Audio function control	Enable/disable by BIOS Setup
Mono or stereo	Stereo
Compatibility	ALC662-VD meets audio performance and function requirements for the latest Microsoft Windows Logo Program and Lync specification. It feature three stereo DACs, two stereo ADCs, and legacy analog input to analog output mixing, to provide fully integrated audio solutions for multimedia PCs and ultra mobile devices. Two stereo ADCs and one stereo digital microphone converter are integrated and can support a microphone array with Acoustic Echo Cancellation (AEC), Beam Forming (BF), and Noise Suppression (NS) technologies, with EAX/Direct Sound 3D/I3DL2 compatibility.
Music synthesizer	No
Sampling rate	192kHz (max.)
MPU-401 UART support	No
Microphone/Headphone jack	Supported

Environmental Requirements

Item	Specification
Temperature	
Operating	+5°C ~ +35°C
Non-operating	-20 ~ +60°C (Storage package)
Humidity	
Operating	15% to 80% RH
Non-operating	10% to 90% RH
Vibration	
Operating (unpacked)	5 ~ 500 Hz: 2.20g RMS random, 10 minutes per axis in all 3 axes. 5 ~500 Hz: 1.09g RMS random, 1 hour per axis in all 3 axes.

Power Management

Devices	S1	S3	S4	S5
Power Button	V	V	V	V
USB Keyboard/Mouse	V	V	N/A	N/A
PME	Disabled	Disabled	Disabled	Disabled
RCT	Disabled	Disabled	Disabled	Disabled
WOR	Disabled	Disabled	Disabled	Disabled

- Devices wake up from S3 should be less than.
- Devices wake up from S5 should be less than 10 seconds.

Power Management Function(ACPI support function)

Device Standby Mode

- Independent power management timer for hard disk drive devices(0-15 minutes,time step=1minute).
- Hard Disk drive goes into Standby mode(for ATA standard interface).
- Disable V-sync to control the VESA DPMS monitor.
- Resume method:device activated (keyboard for DOS, keyboard &mouse for Windows).
- Resume recovery time 3-5sec

Global Standby Mode

- Global power management timer(2-120minutes,time step=10minute).
- Hard disk drive goes into Standby mode(for ATA standard interface).
- Disable H-sync and V-sync signals to control the VESA DPMS monitor.
- Resume method: Resume to original state by pushing external switch Button,modem ring in,keyboard an mouse for APM mode.
- Resume recovery time :7-10sec

Suspend Mode

- Independent power management timer(2-120minutes,time step=10minute)or pushing extern switch button.
- CPU goes into SMM
- CPU asserts STPCLK# and goes into the Stop Grant State.
- LED on panel turns amber colour.
- Hard disk drive goes into SLEEP mode (for ATA standard interface).
- Disable H-sync and V-sync signals to control the VESA DPMS monitor.
- Ultra I/O and VGA chip go into power saving mode.
- Resume method: Resume to original state by pushing external switch Button,modem ring in,keyboard an mouse for APM mode
- Return to original state by pushing external switch button,modem ring in and USB keyboard for ACPI mode.

ACPI

- ACPI specification 1.0b
- S0,S1,S2 and S5 sleep state support.
- On board device power management support.
- On board device configuration support.

System Utilities

CMOS Setup Utility

CMOS setup is a hardware configuration program built into the system ROM, called the complementary metal-oxide semiconductor (CMOS) Setup Utility. Since most systems are already properly configured and optimized, there is no need to run this utility. You will need to run this utility under the following conditions.

- When changing the system configuration settings
- When redefining the communication ports to prevent any conflicts
- When modifying the power management configuration
- When changing the password or making other changes to the security setup
- When a configuration error is detected by the system and you are prompted ("Run Setup" message) to make changes to the CMOS setup

NOTE: If you repeatedly receive Run Setup messages, the battery may be bad. In this case, the system cannot retain configuration values in CMOS. Ask a qualified technician for assistance.

CMOS setup loads the configuration values in a battery-backed nonvolatile memory called CMOS RAM. This memory area is not part of the system RAM which allows configuration data to be retained when power is turned off.

Before you run the *CMOS Setup Utility*, make sure that you have saved all open files. The system reboots immediately after you close the Setup.

NOTE: *CMOS Setup Utility* will be simply referred to as "BIOS", "Setup", or "Setup utility" in this guide.

The screenshots used in this guide display default system values. These values may not be the same those found in your system.

Entering CMOS setup

1. Turn on the server and the monitor.

If the server is already turned on, close all open applications, then restart the server.

2. During POST, press **Delete**.

If you fail to press **Delete** before POST is completed, you will need to restart the server.

The Setup Main menu will be displayed showing the Setup's menu bar. Use the left and right arrow keys to move between selections on the menu bar.

Navigating Through the Setup Utility

Use the following keys to move around the Setup utility.

- **Left** and **Right** arrow keys – Move between selections on the menu bar.
- **Up** and **Down** arrow keys – Move the cursor to the field you want.
- **PgUp** and **PgDn** keys – Move the cursor to the previous and next page of a multiple page menu.
- **Home** – Move the cursor to the first page of a multiple page menu.
- **End** – Move the cursor to the last page of a multiple page menu.
- **+** and **-** keys – Select a value for the currently selected field (only if it is user-configurable). Press these keys repeatedly to display each possible entry, or the **Enter** key to choose from a pop-up menu.

NOTE: Grayed-out fields are not user-configurable.

- **Enter** key – Display a submenu screen.

NOTE: Availability of submenu screen is indicated by a (>).

- **Esc** – If you press this key:
 - On one of the primary menu screens, the Exit menu displays.
 - On a submenu screen, the previous screen displays.
 - When you are making selections from a pop-up menu, closes the pop-up without making a selection.
- **F1** – Display the General Help panel.
- **F6** – Press to load optimized default system values.
- **F7** – Press to load fail-safe default system values.
- **F10** – Save changes made the Setup and close the utility.

Setup Utility Menus

Main

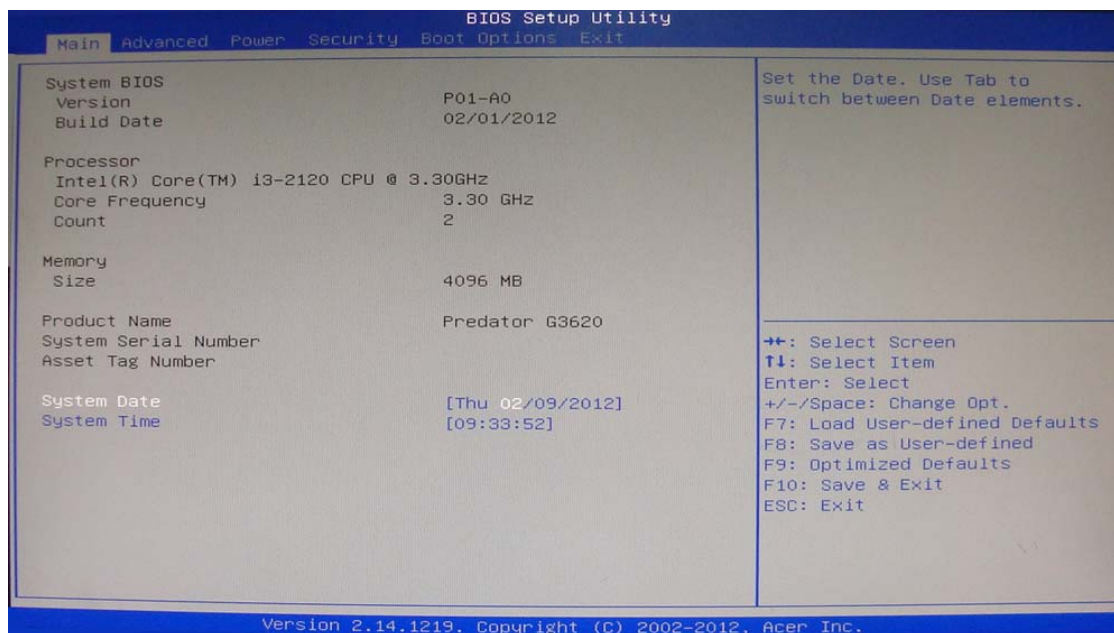

The Setup Main menu includes the following main setup categories.

Parameter	Description
System BIOS	
Version	Version number of the BIOS setup utility.
Build Date	Date when the BIOS setup utility was built
Processor	
Core Frequency	Core speed of the CPU installed on the system.
Count	Physical CPU count
Memory	
Size	Total size of system memory installed on the system.
Product Name	Product name of the system.
System Serial Number	Serial number of the system.
Asset Tag Number	Asset tag number of this system.
System Date	Set the date following the weekday-month-day-year format.
System Time (hh:mm:ss)	Set the system time following the hour-minute-second format.

In the descriptive table following each of the menu screenshots, settings in **boldface** are the default and suggested settings.

Advanced

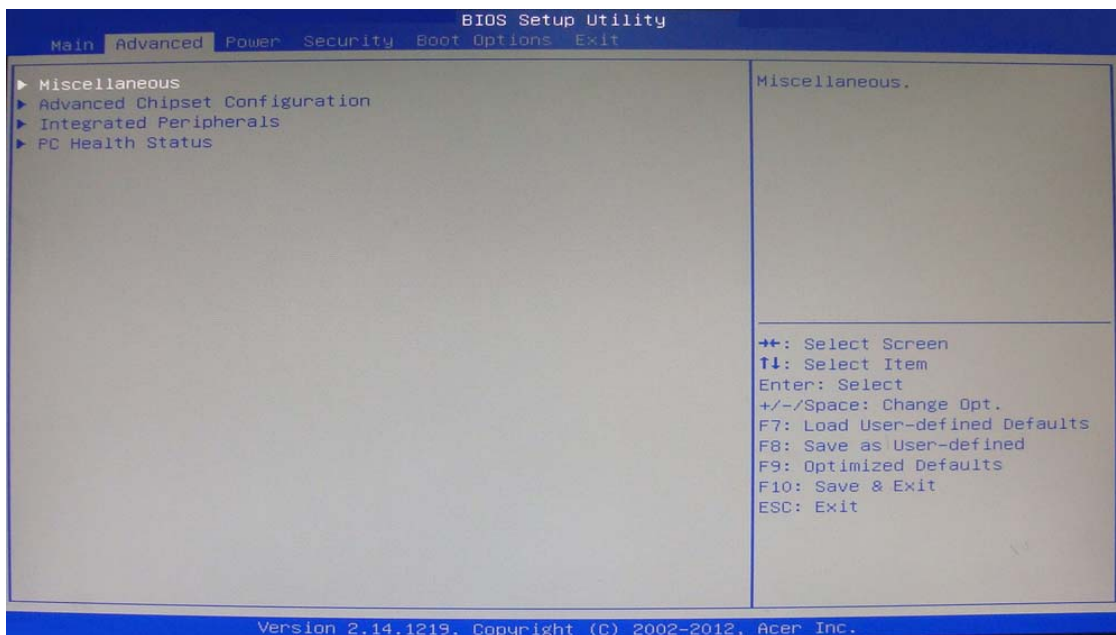

Parameter	Description
Miscellaneous	Press Enter to access the Miscellaneous submenu
Advanced Chipset Configuration	Press Enter to access the Advanced Chipset Configuration submenu
Integrated Peripherals	Press Enter to access the Integrated Peripherals submenu
PC Health Status	Press Enter to access the PC Health Status submenu

Miscellaneous

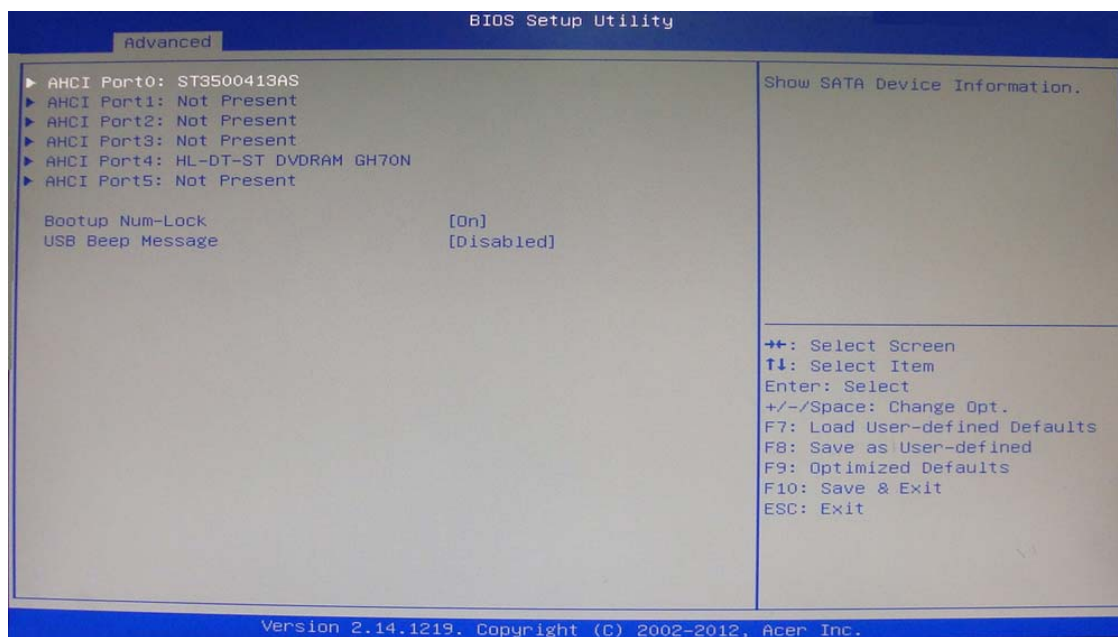

Parameter	Description	Option
AHCI Port0/1/2/3/4/5	Displays the status of auto detection of the AHCI device.	
Bootup Num-lock	Selects power on state for Num Lock.	On Off
USB Beep Message	Enables or disables BIOS to display error beeps or messages during USB device enumeration.	Enabled Disabled

Advanced Chipset Configuration

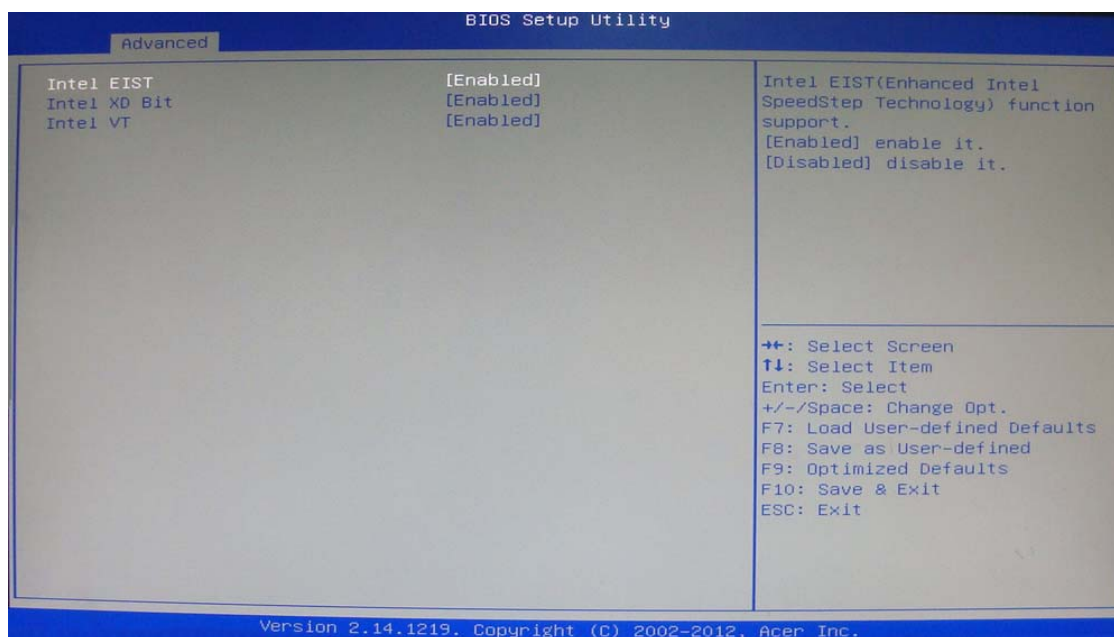

Intel EIST	When enabled, this feature allows the OS to reduce power consumption. When disabled, the system operates at maximum CPU speed.	Enabled Disabled
Intel XD Bit	When enabled, the processor disables code execution when a worm attempts to insert a code in the buffer preventing damage and worm propagation. When disabled, the processor forces the Execute Disable (XD) Bit feature flag to always return to 0.	Enabled Disabled
Intel VT	Enables or disables the Virtualization Technology (VT) availability. If enabled, a virtual machine manager (VMM) can utilize the additional hardware virtualization capabilities provided by this technology. Note: A full reset is required to change the setting.	Enabled Disabled

Integrated Peripherals

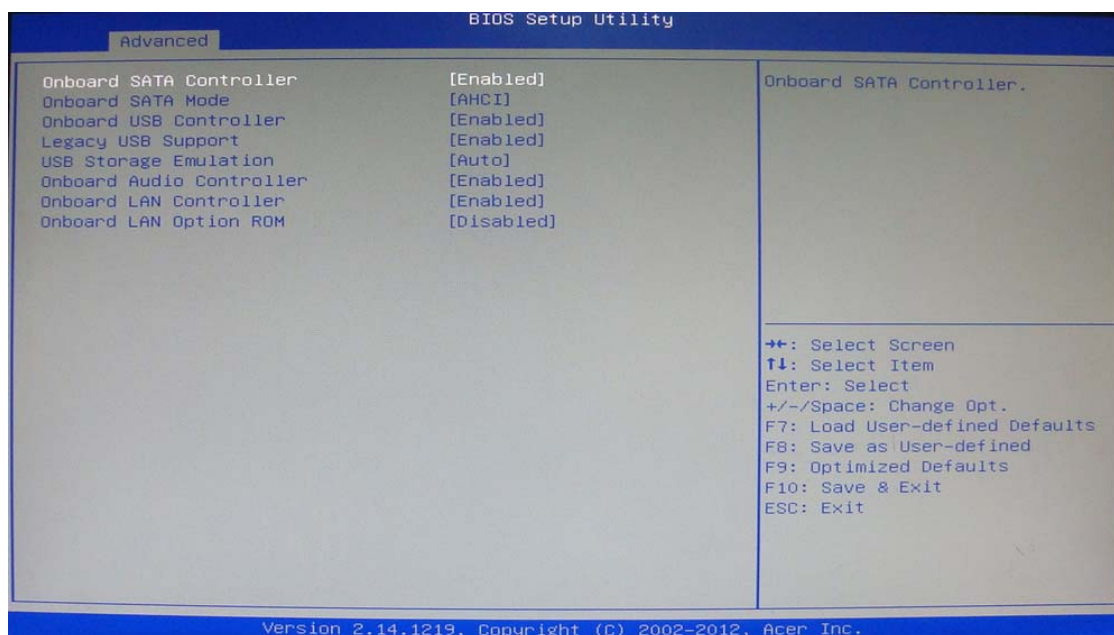

Parameter	Description	Option
Onboard SATA Controller	Enables or disables the onboard SATA controller.	Enabled Disabled
Onboard SATA Mode	Select an operating mode for the onboard SATA.	Native IDE AHCI
Onboard USB Controller	Enables or disables the onboard USB controller.	Enabled Disabled
Legacy USB Support	Enables or disables support for legacy USB devices.	Enabled Disabled
USB Storage Emulation	If Auto, USB device equal or less than 2GB will be emulated as Floppy and remaining as harddrive. Forced FDD option can be used to force a HDD formatted drive to boot as FDD (Ex.ZIP drive).	Auto Floppy Hard Disk
Onboard Audio Controller	Enables or disables the onboard audio controller.	Enabled Disabled
Onboard LAN Controller	Enables or disables the onboard LAN controller.	Enabled Disabled
Onboard LAN Option ROM	Enables or disables the load of embedded option ROM for onboard network controller.	Enabled Disabled

PC Health Status

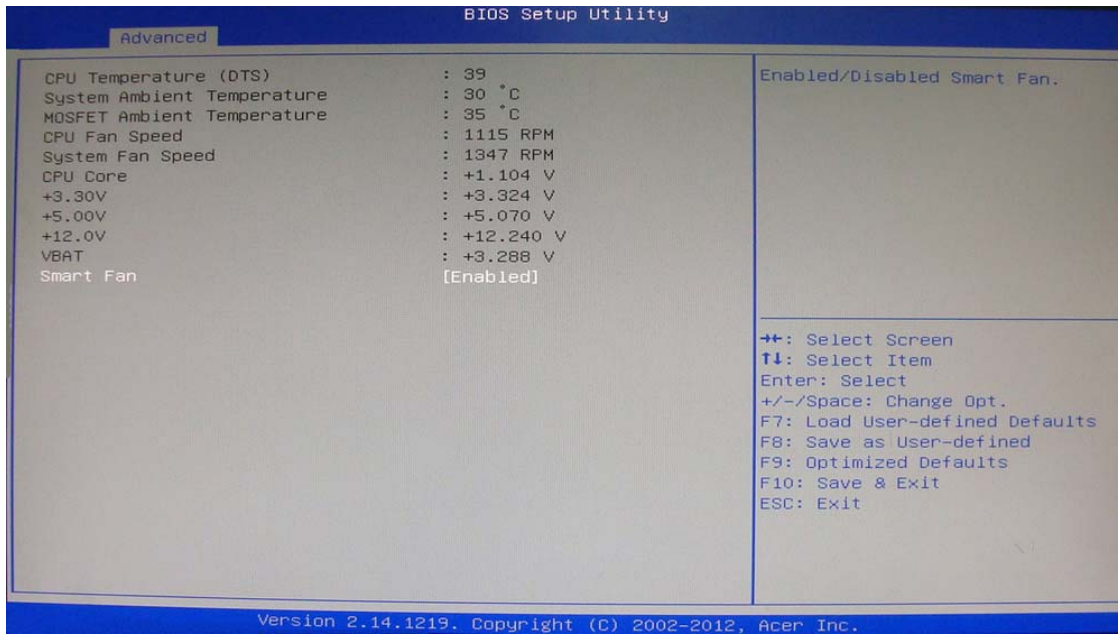

Parameter	Description	Option
Smart Fan	Enables or disables the smart system fan control function.	Enabled Disabled

Power

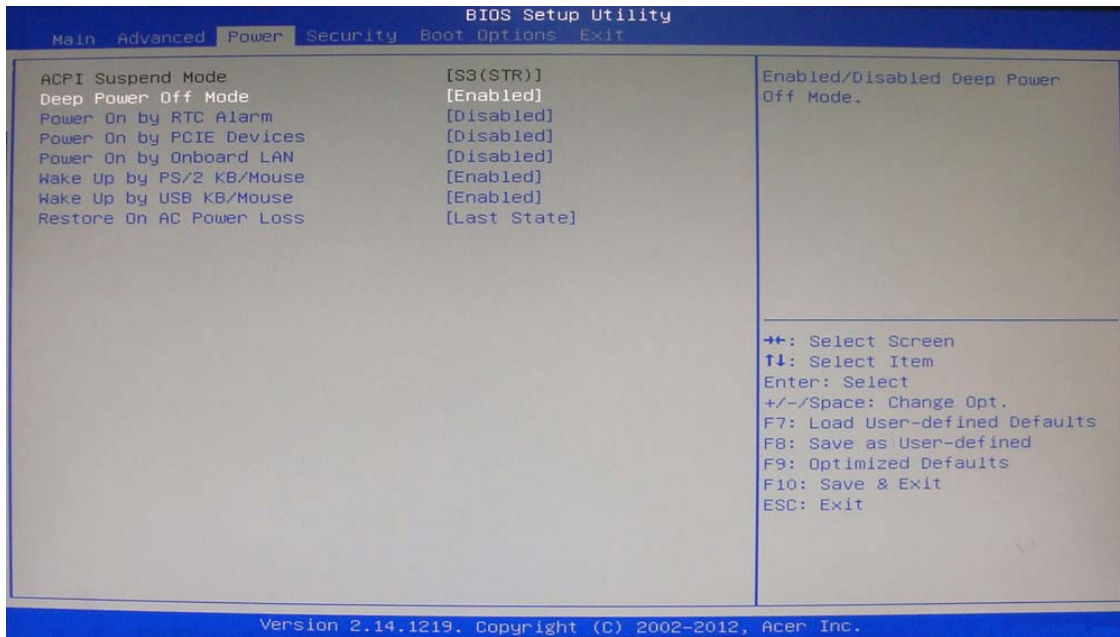

Parameter	Description	Option
ACPI Suspend Mode	Select an ACPI state.	S3 (STR) S1 (POS)
Deep Power Off Mode	Select the Deep power off Mode	Enabled Disabled
Power On by RTC Alarm	Enables or Disables to wake up the system by RTC Alarm Function	Enabled Disabled
Power On by PCIE Devices	This system can be turned off with a software commend. If you enable this item, the system can automatically resume if there is an incoming call on the PCIE LAN card.You must use an ATX power supply in order to use this feature.Use this item to dowake-up action if inserting the PCIE card.	Enabled Disabled
Power On by Onboard LAN	Enables or disables an onboard LAN controller to generate a wake event.	Enabled Disabled
Wake Up by PS/2 KB/ Mouse	Enables or disables to wake up the system from a power saving mode using a PS2 keyboard or mouse.	Enabled Disabled
Wake Up by USB KB/ Mouse	If enabled, press any key or click the mouse will wake system from S1/ S3 state.	Enabled Disabled
Restore On AC Power Loss	Enables or disables the system to reboot after a power failure or interrupt occurs.	Off On Last State

Security

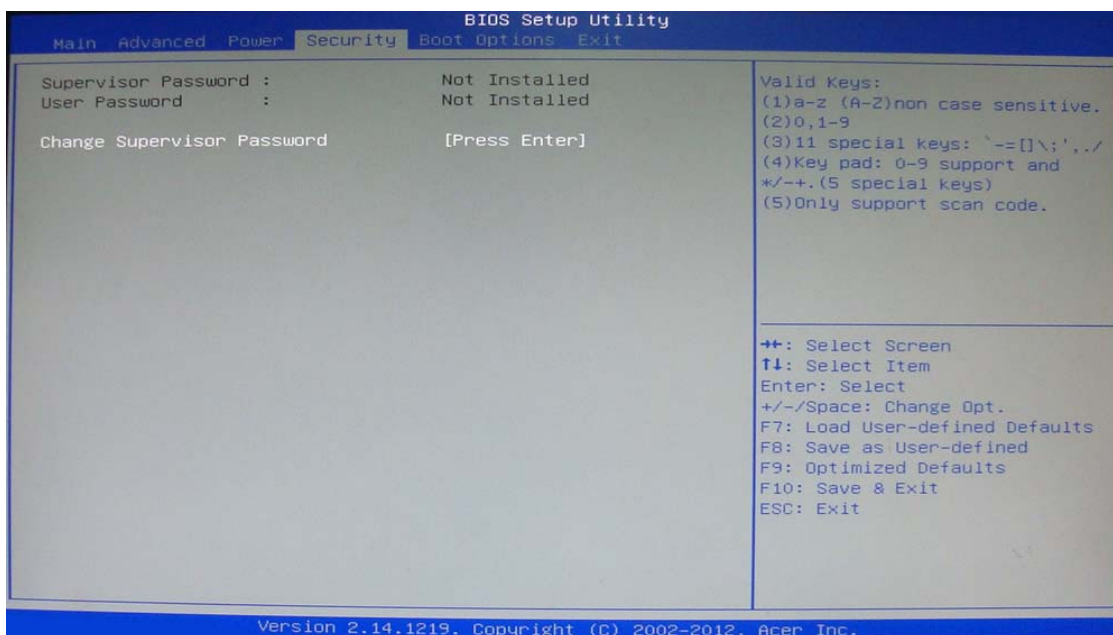

Parameter	Description	Option
Supervisor Password	This item indicates whether a supervisor password has been set. If the password has been installed, Installed displays. If not, Not Installed displays.	
User Password	This item allows you to change user password.	
Change Supervisor Password	You can select this option and press <Enter> to access the sub menu. You can use the sub menu to change the supervisor password.	

Setting a supervisor password

1. Use the up/down arrow keys to select Change Supervisor Password menu then press **Enter**.
A password box will appear.
2. Type a password then press **Enter**.
The password may consist up to six alphanumeric characters (A-Z, a-z, 0-9)
3. Retype the password to verify the first entry then press **Enter** again.
4. Press **F10**.
5. Select **Yes** to save the new password and close the Setup Utility.

Changing the supervisor password

1. Use the up/down arrow keys to select Change Supervisor Password menu then press **Enter**.
2. Type the original password then press **Enter**.
3. Type a new password then press **Enter**.
4. Retype the password to verify the first entry then press **Enter** again.
5. Press **F10**.
6. Select **Yes** to save the new password and close the Setup Utility.

Removing a supervisor password

1. Use the up/down arrow keys to select Change Supervisor Password menu then press **Enter**.
2. Enter the current password then press **Enter**.
3. Press **Enter** twice without entering anything in the password fields.

Boot Options

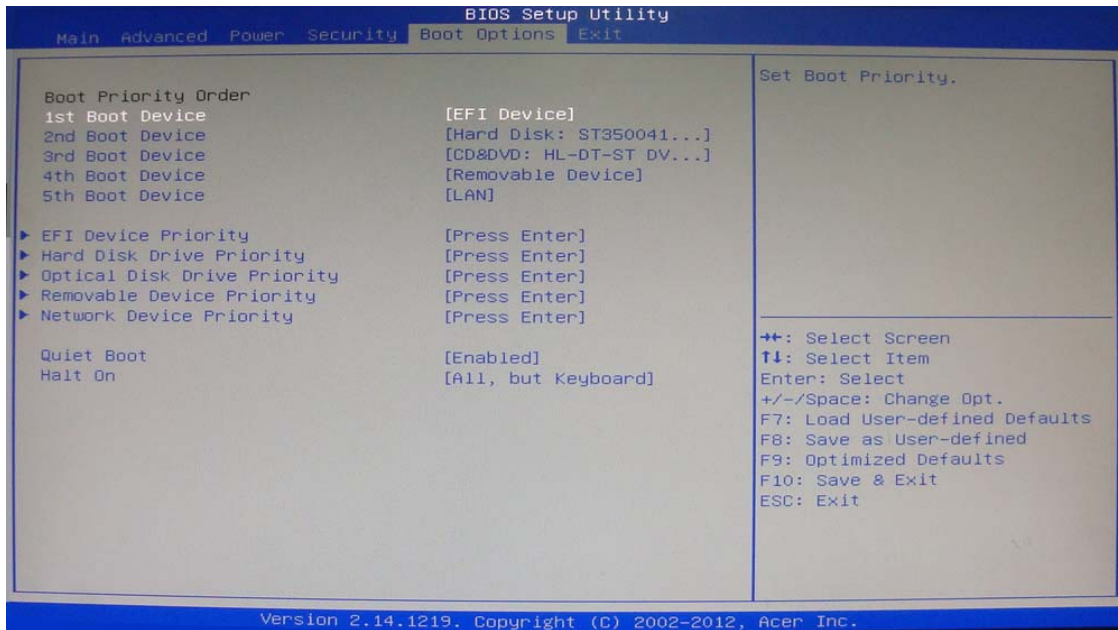

1st/2nd/3rd/4th/5th Boot Device	Specifies the boot order from the available devices.	EFI Hard Disk CD^DVD Removable Device LAN
EFI Device Priority	Press Enter to access the EFI Device Priority submenu and specify the boot device priority sequence from available EFI devices.	
Hard Disk Drive Priority	Press Enter to access the Hard Disk Drive Priority submenu and specify the boot device priority sequence from available hard drives.	
Optical Disk Drive Priority	Press Enter to access the Optical Disk Drive Priority submenu and specify the boot device priority sequence from available optical drives.	
Removable Device Priority	Press Enter to access the Removable Device Priority submenu and specify the boot device priority sequence from available removable drives.	
Network Device Priority	Press Enter to access the Network Device Priority submenu and specify the boot device priority sequence from available network drives.	
Quiet Boot	When enabled, the BIOS splash screen displays during startup. When disabled, the diagnostic screen displays during startup.	Enabled Disabled
Halt On	Determines whether the system will stop for an error during the POST.	All, but keyboard No Errors All Errors

Exit

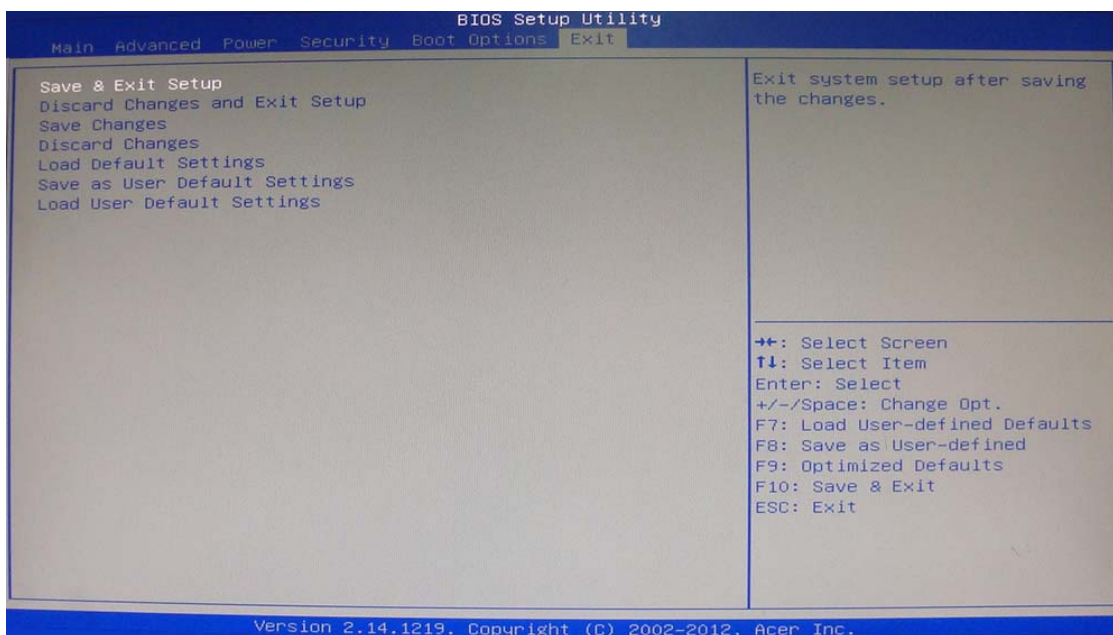

Parameter	Description
Save & Exit Setup	When you have completed the system configuration changes, select this option to leave the BIOS Setup Utility and reboot the computer, so the new system configuration parameters can take effect. Select Save & Exit Setup from the Exit menu and press Enter.
Discard Changes and Exit Setup	Select this option to quit the BIOS Setup Utility without making any permanent changes to the system configuration, and reboot the computer. Select Discard Changes and Exit Setup from the Exit menu and press Enter.
Save Changes	Select this option and press Enter to save all the changes and return to the BIOS Setup Utility.
Discard Changes	Use this item enables you to discard any changes that you have made.
Load Default Settings	To set this feature, select Load Default Settings from the Exit menu and press Enter. Then, select OK to allow the BIOS to automatically load optimal defaults to the BIOS settings. The Optimal settings are designed for maximum system performance, but may not work best for all computer applications.
Save as User Default Settings	Select this option and press Enter to save changes that you have made as user defaults.
Load User Default Settings	Select this option and press Enter to restore user defaults.

System Disassembly and Assembly

This chapter contains step-by-step procedures on how to disassemble and assemble the desktop computer for maintenance and troubleshooting.

Disassembly Requirements

To disassemble the computer, you need the following tools:

- Wrist grounding strap and conductive mat for preventing electrostatic discharge
- Flat-blade screwdriver
- Philips screwdriver
- Hex screwdriver
- Plastic flat-blade screwdriver
- Plastic tweezers

NOTE: The screws for the different components vary in size. During the disassembly process, group the screws with the corresponding components to avoid mismatch when putting back the components.

Pre-disassembly Procedure

Before proceeding with the disassembly procedure, perform the steps listed below:

1. Turn off the system and all the peripherals connected to it.
2. Unplug the power cord from the power outlets.
3. Unplug the power cord from the system.
4. Unplug all peripheral cables from the system.
5. Place the system unit on a flat, stable surface.

Removing the Side Panel

1. Remove the two screws located on the rear edge of the side panel.



2. Slide the side panel toward the back of the chassis until the tabs on the cover disengage with the slots on the chassis.
3. Lift the side panel away from the server and put it aside for reinstallation later.



Removing the Front Bezel

1. Remove the side panel. Refer to the previous section for instructions.
2. Release the front bezel from the chassis interior.

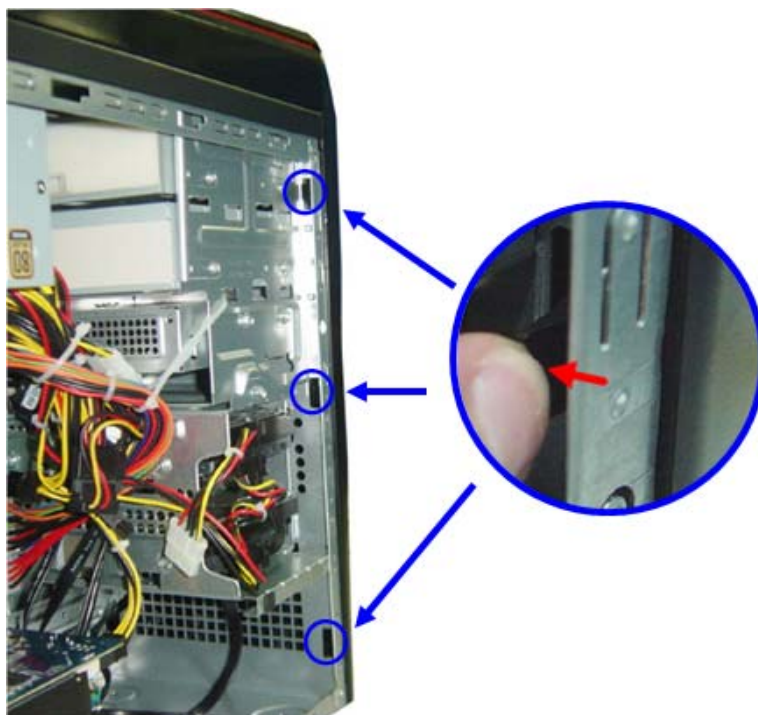

3. Pull the bezel away from the chassis.



Removing the Heat Sink Fan Assembly

WARNING: The heat sink becomes very hot when the system is on. NEVER touch the heat sink with any metal or with your hands.

1. Use a long-nosed screwdriver to loosen the four screws on the heat sink, in the order as shown below.

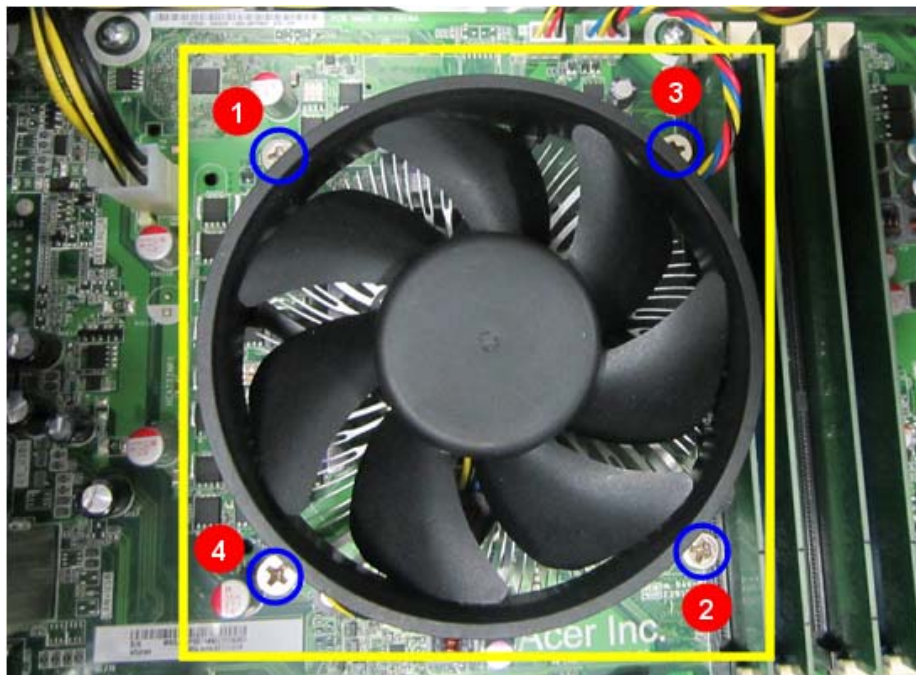

Note: CPU Fan has been highlighted with the yellow rectangle as above image shows. Please detach the CPU

Fan and follow local regulations for disposal.

2. Lift the heat sink fan assembly away from the mainboard.

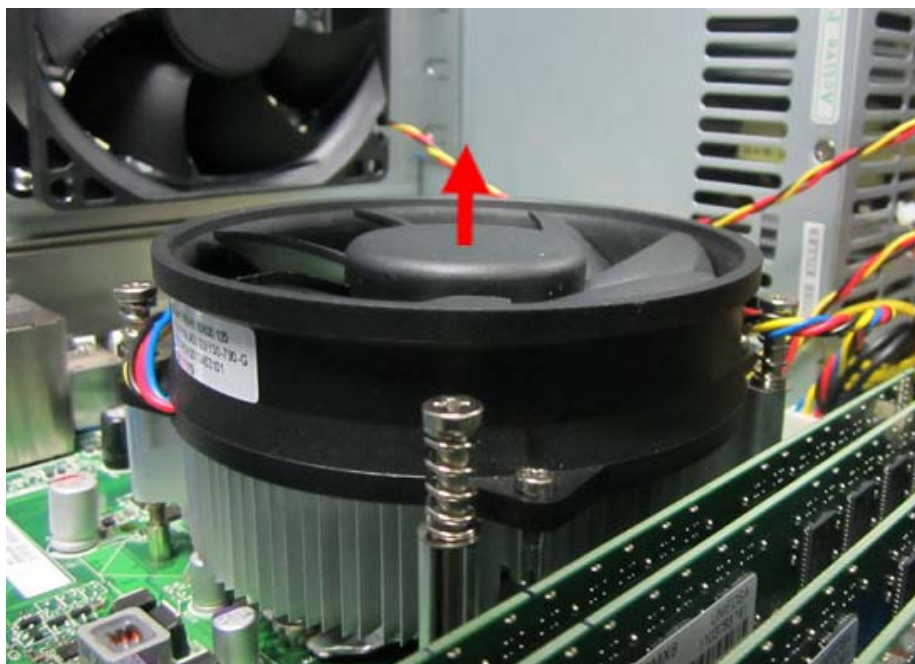

3. Disconnect the fan cable from the mainboard.



4. Remove the heat sink fan assembly then lay it down in an upright position—with the thermal patch facing upward. Do not let the thermal patch on the heat sink fan assembly touch the work surface.
5. Use an alcohol pad to wipe off the thermal grease from both the heat sink and the processor.

Removing the Processor

IMPORTANT: Before removing a processor from the mainboard, make sure to create a backup file of all important data.

WARNING: The processor becomes very hot when the system is on. Allow it to cool off first before handling.

1. Release the load lever.



2. Lift the load lever and load plate to the fully open, upright position (1) and (2).

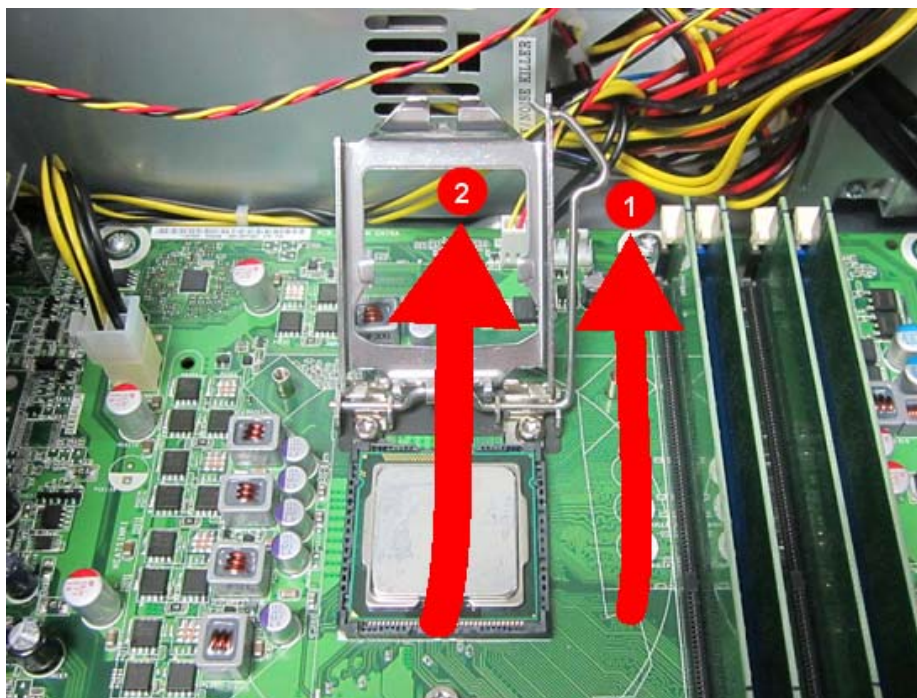

3. Pull out the processor from the socket.

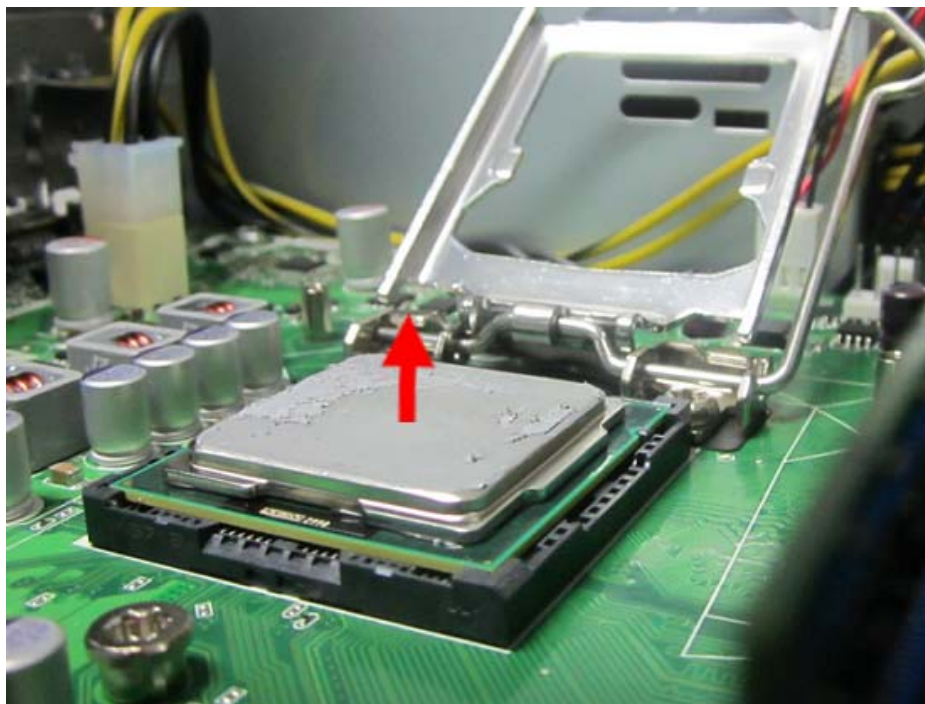

IMPORTANT: If you are going to install a new processor, note the arrow on the corner to make sure the processor is properly oriented over the socket.



Removing the VGA Card

1. Remove the four screws that secures the card to the chassis.

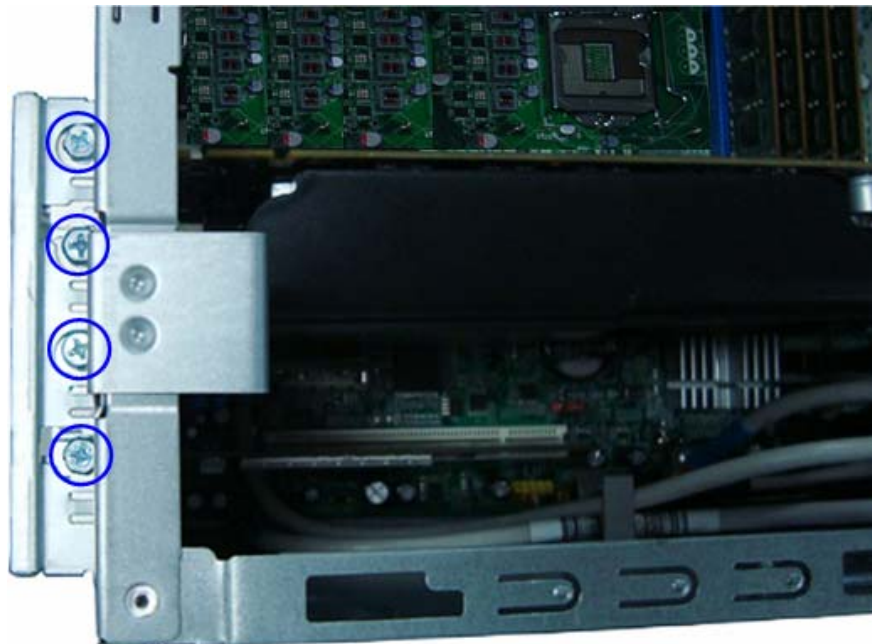

2. Open PCI Latch.

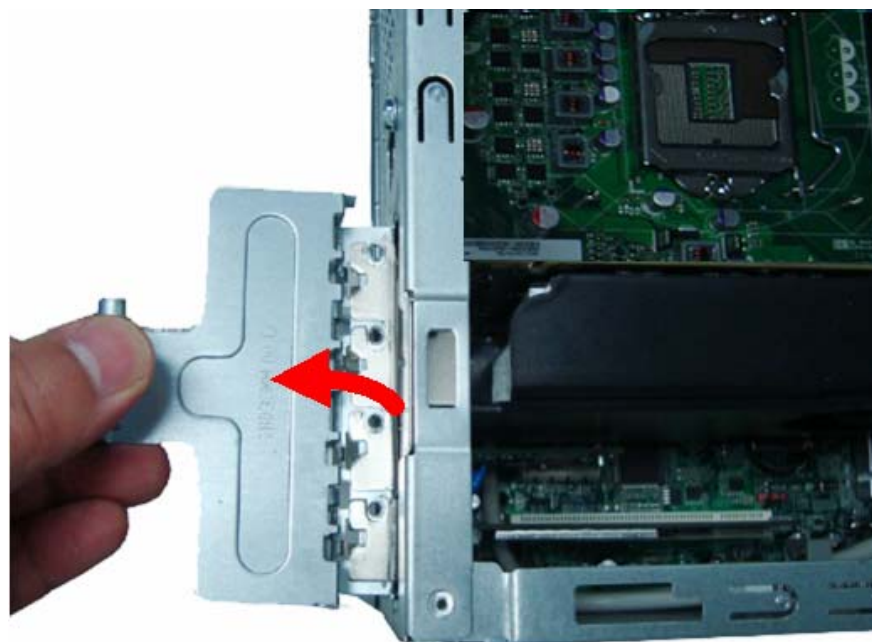

3. Disconnect the power cable from the VGA card.

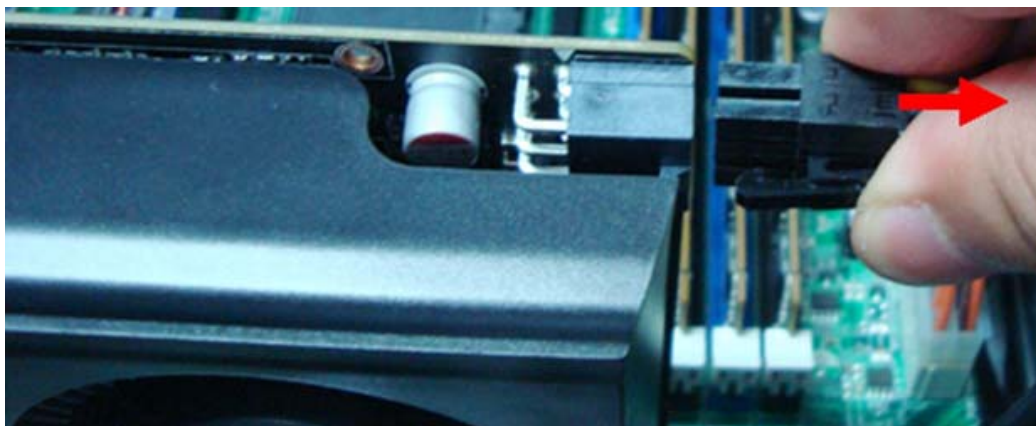

4. Firstly press retention latch down to unlock the card from the PCI slot., then gently pull the card to remove it from the mainboard.

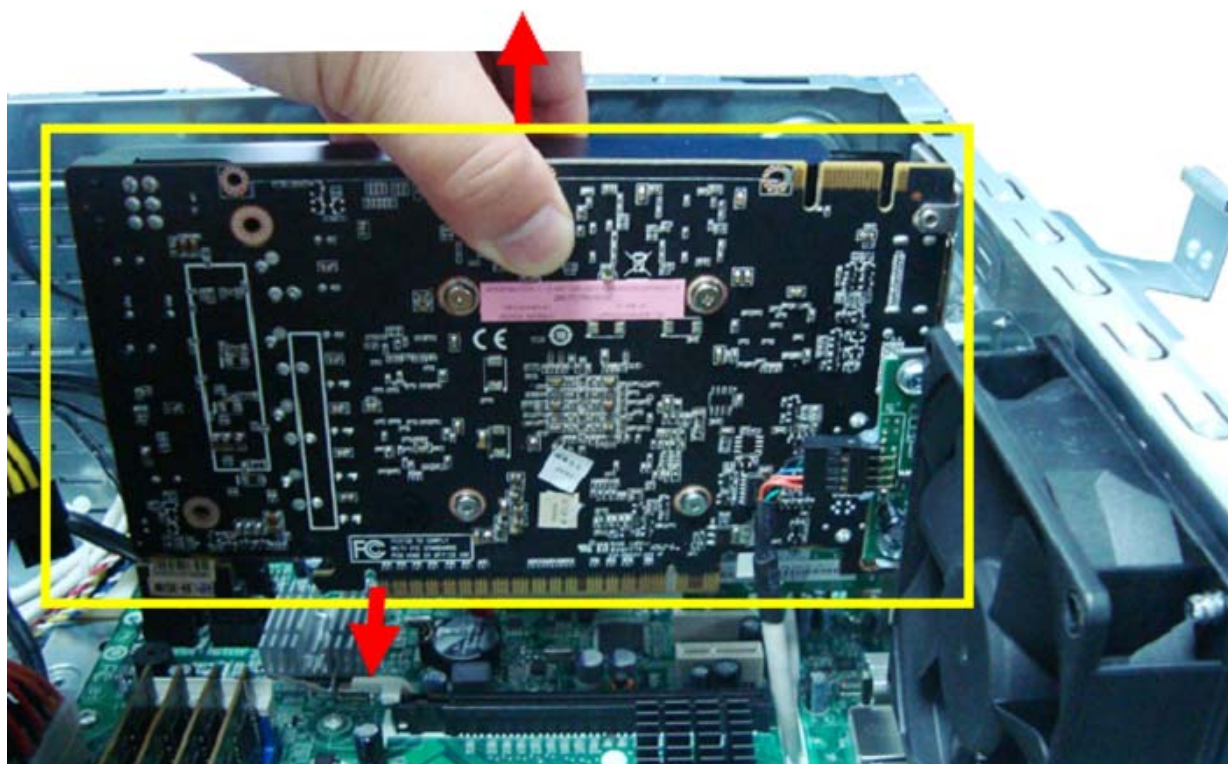

Note: Circuit boards >10 cm² has been highlighted with the yellow rectangle as above image shows. Please detach the Circuit boards and follow local regulations for disposal.

Removing the Wireless Lan Card

1. Gently pull the card to remove it from the mainboard.

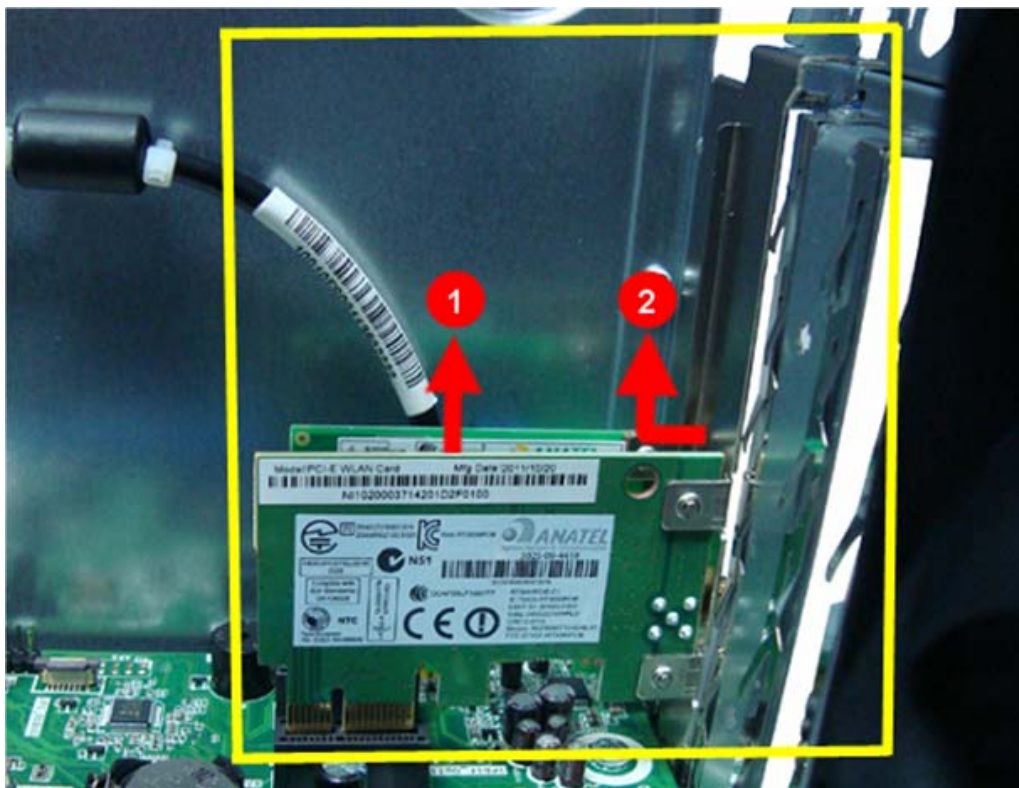

Note: Circuit boards >10 cm² has been highlighted with the yellow rectangle as above image shows. Please detach the Circuit boards and follow local regulations for disposal.

Removing the Modem Card

1. Gently pull up the expansion board, move it slightly to the left (2) and remove (1) from the slot.

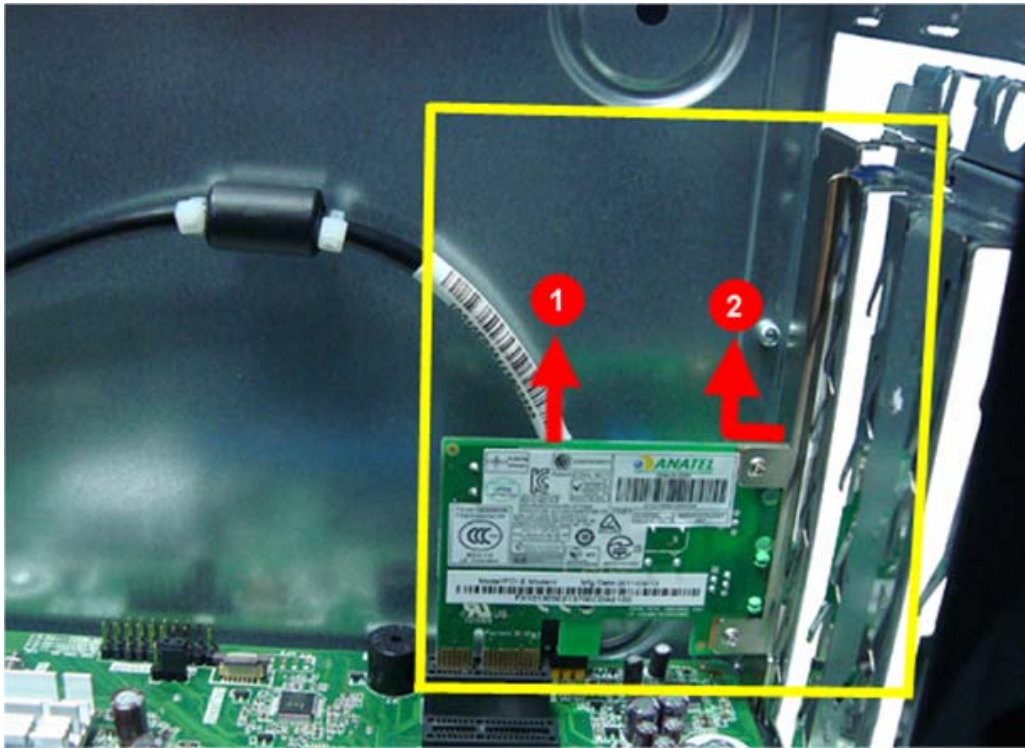

Note: Circuit boards >10 cm² has been highlighted with the yellow rectangle as above image shows. Please detach the Circuit boards and follow local regulations for disposal.

Removing the Memory Modules

IMPORTANT: Before removing any DIMM from the memory board, make sure to create a backup file of all important data.

1. Press the holding clips on both sides of the DIMM slot outward to release the DIMM(1).
2. Gently pull the DIMM upward to pull it away from the M/B(2).

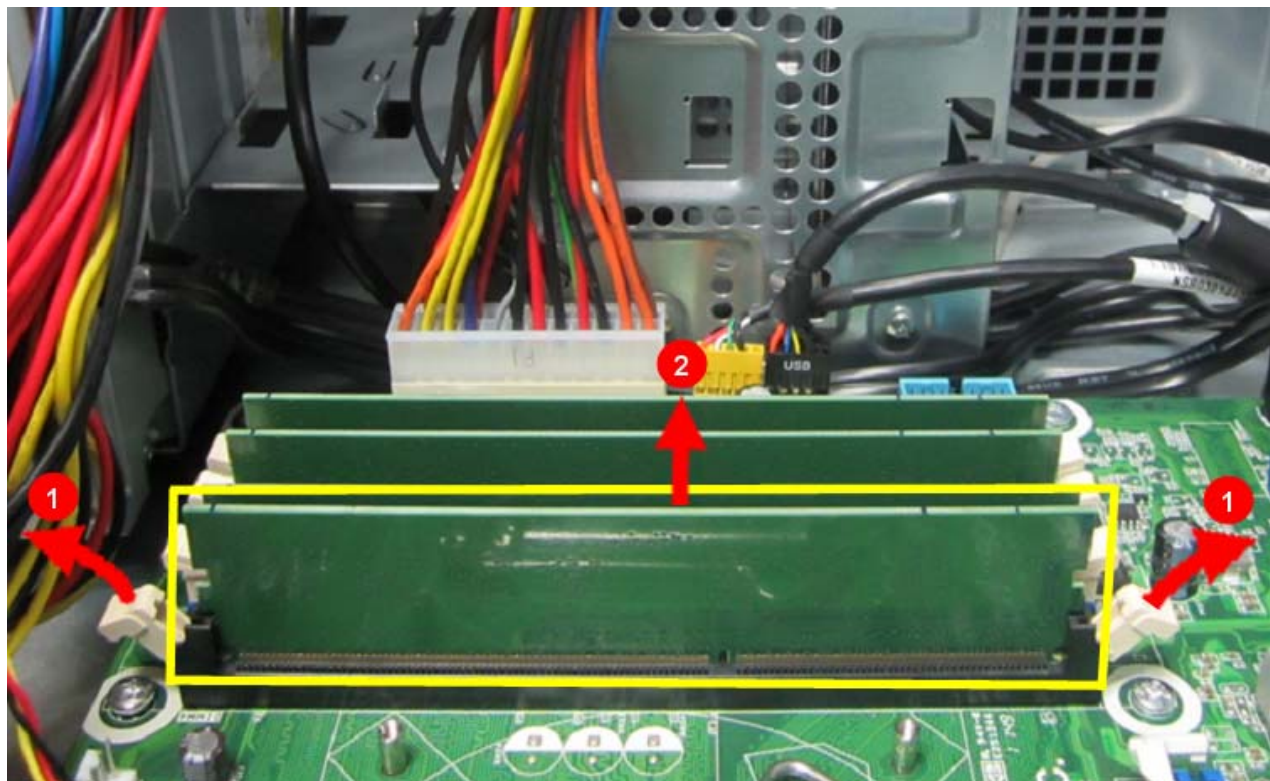

Note: Circuit boards >10 cm² has been highlighted with the yellow rectangle as above image shows. Please detach the Circuit boards and follow local regulations for disposal.

3. Repeat steps 1 and 2 to remove the second, the third, the fourth memory module from the DIMM2,3,4 slot.

Removing the Hard Disk Drive

1. Disconnect the data and power cables from the rear of the optical drive.

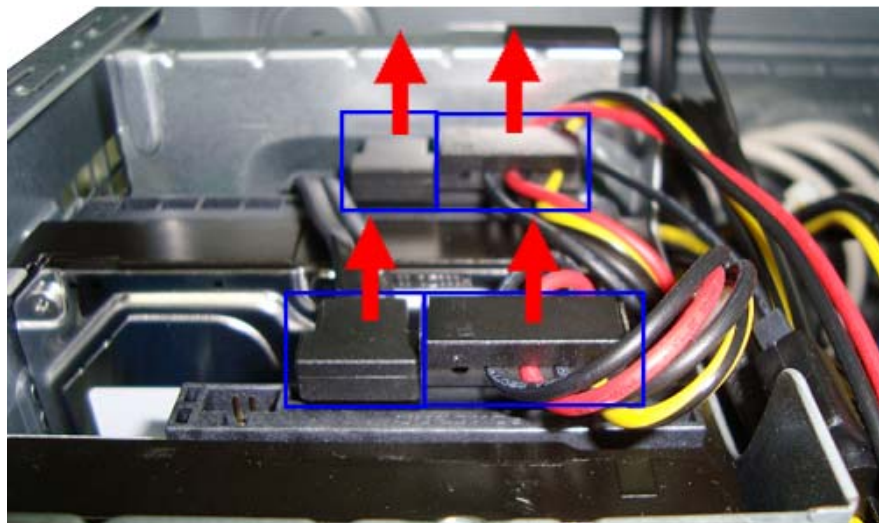

2. Disconnect the other end of the data cable from the main board.

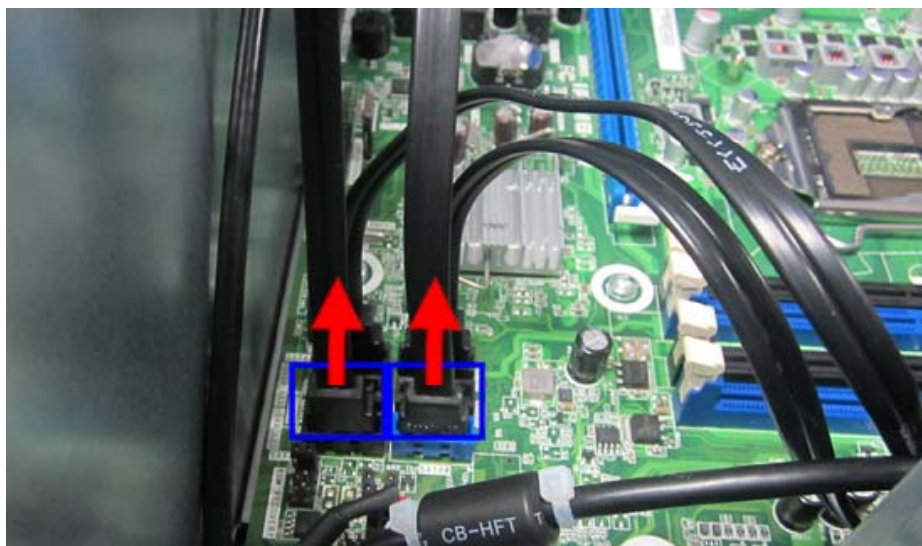

3. Remove the screw that secures the HDD cage to the chassis.



4. Lift the HDD cage up and turn it over.

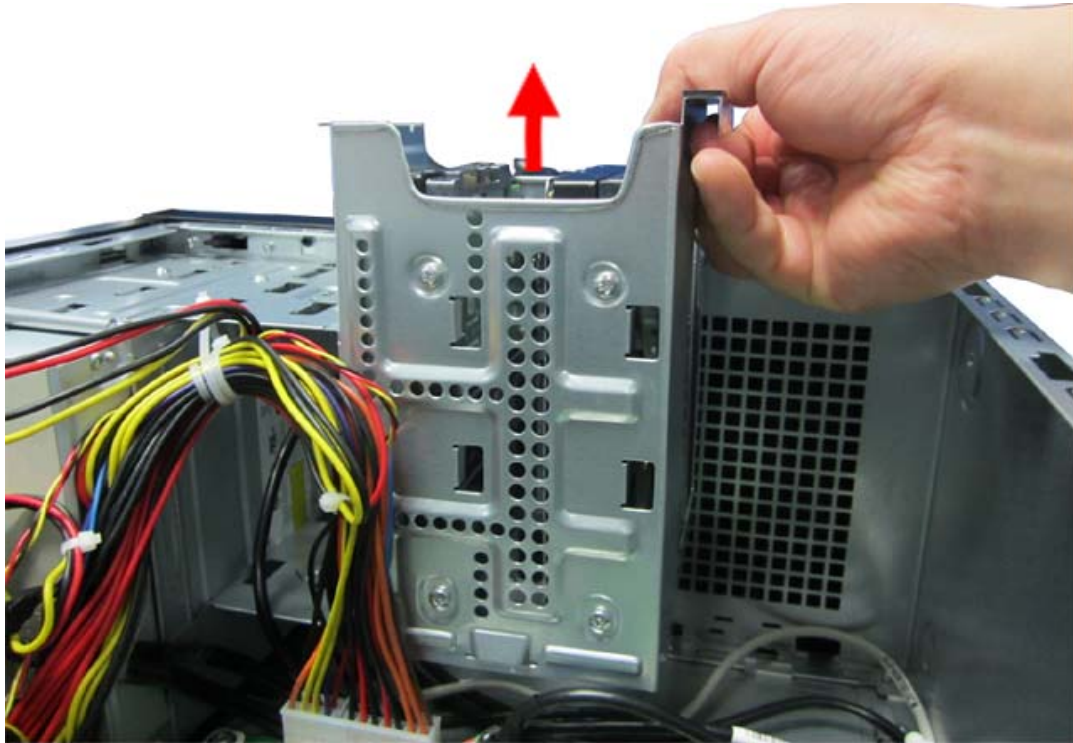

5. Remove the HDD module.
 - a. Remove the eight screws secure the HDD module to the HDD cage.

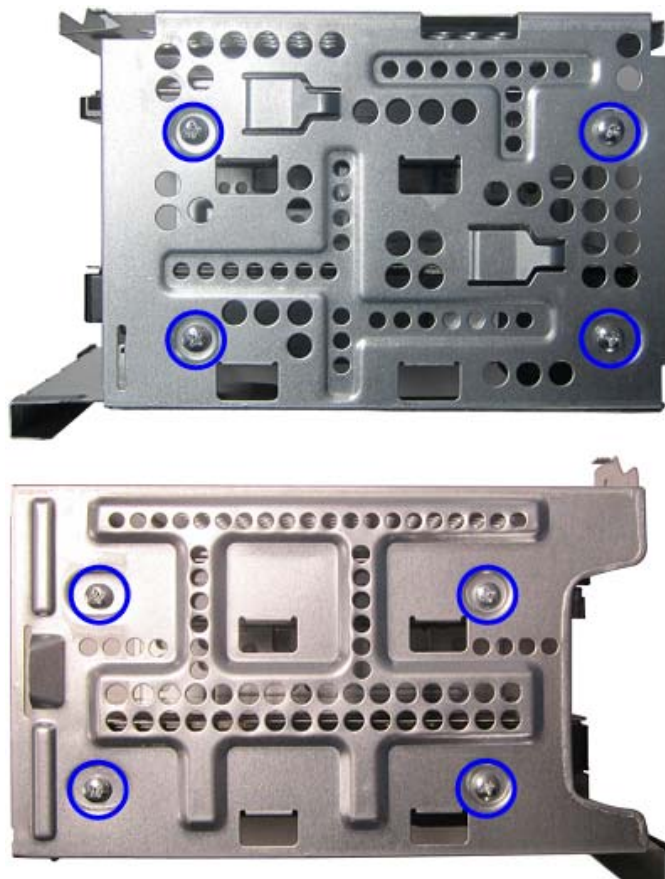

-
- b. Slide the HDD out of the cage.



- c. Use the same way to slide other HDD out of the cage.



Removing the Bracket of Removable HDD

1. Remove the three screws that secures the bracket of removable HDD to the chassis.

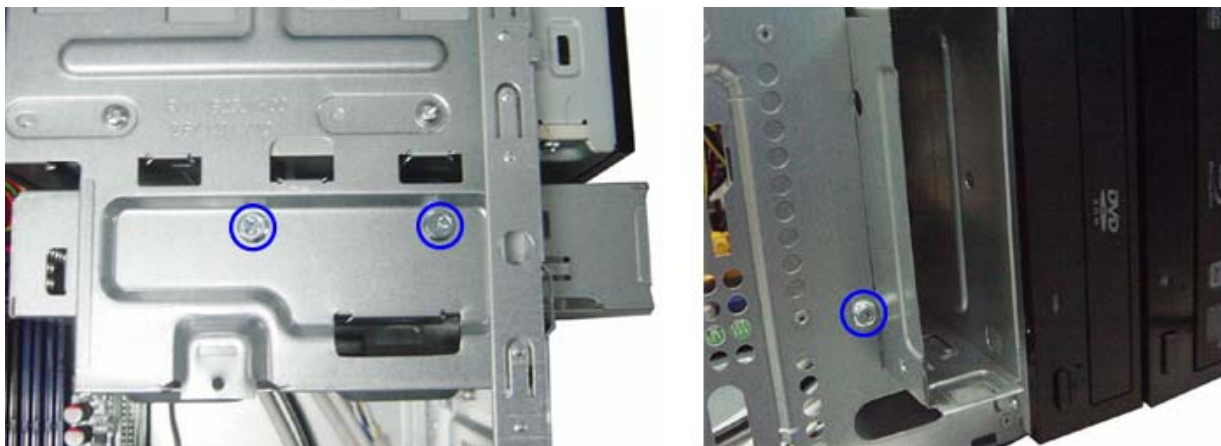

2. Pull the bracket of removable HDD from the chassis.

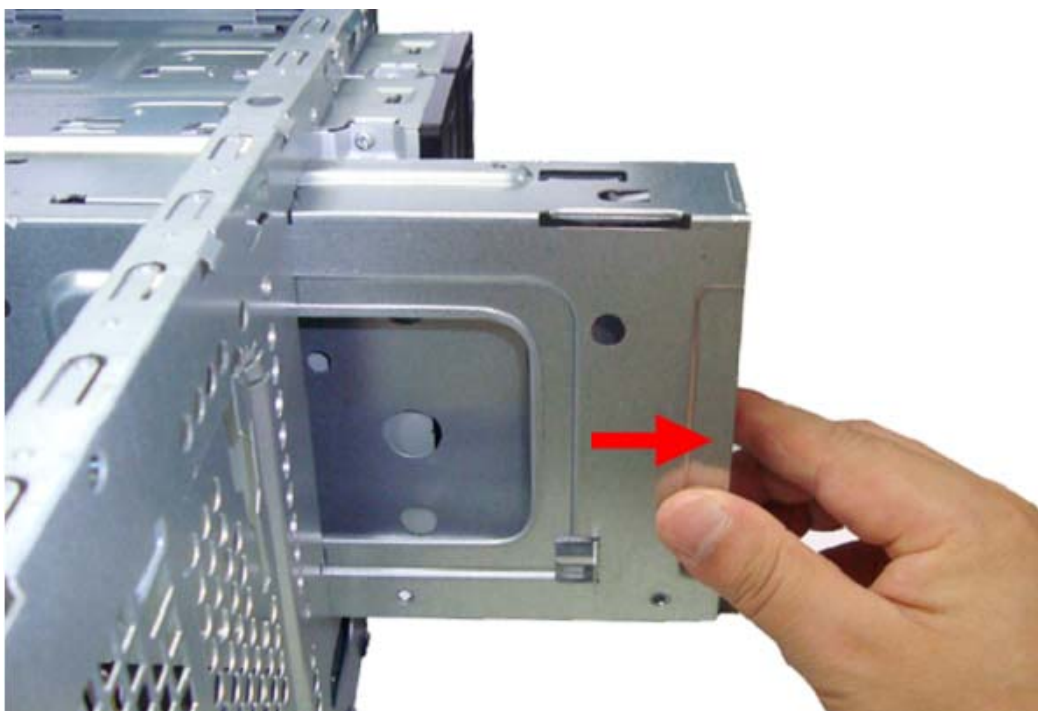

Removing the Optical Drive

1. Disconnect data and power cable from the rear of the optical drive.

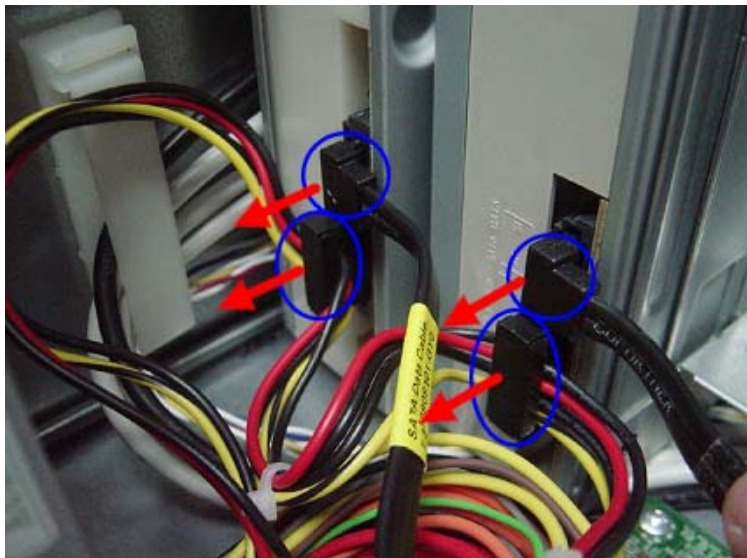

2. Disconnect the other end of the data cable from the mainboard.

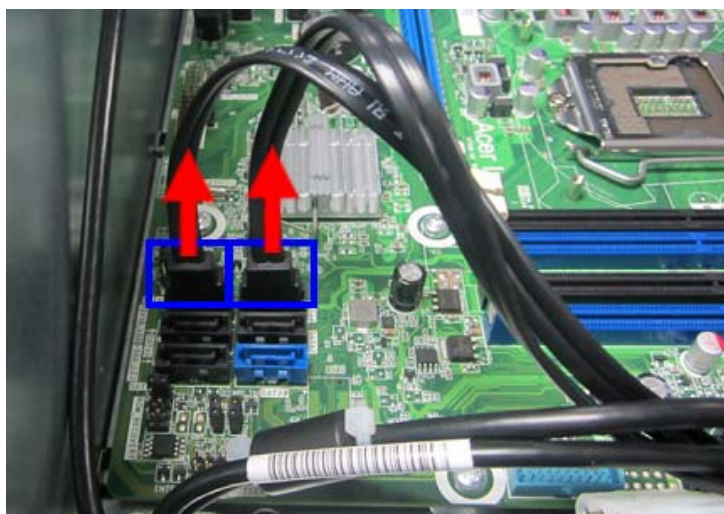

3. Remove the screws that secure the optical drive to the chassis.



4. Pull the slave ODD from the chassis.

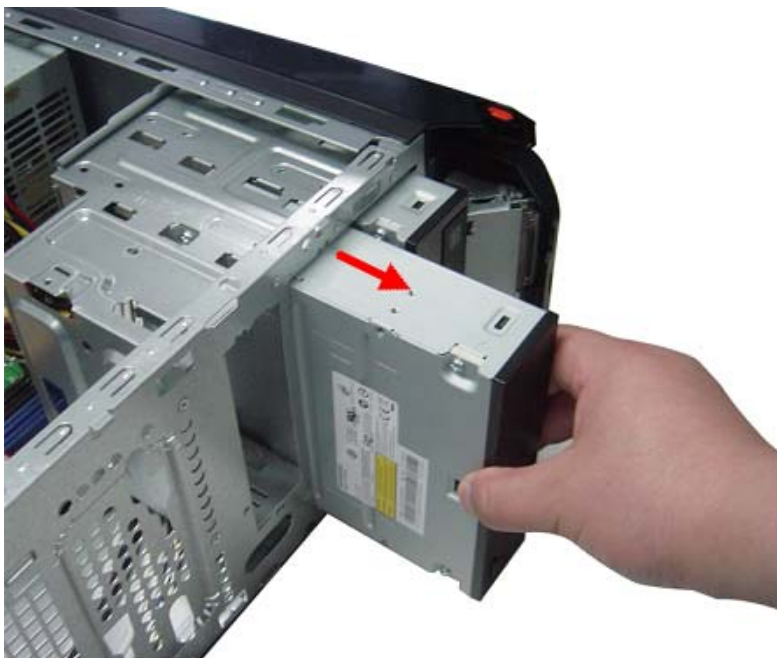

5. Use the same method to take out master ODD.



Removing the System Fan

1. Use a knife to cut the cable tying.

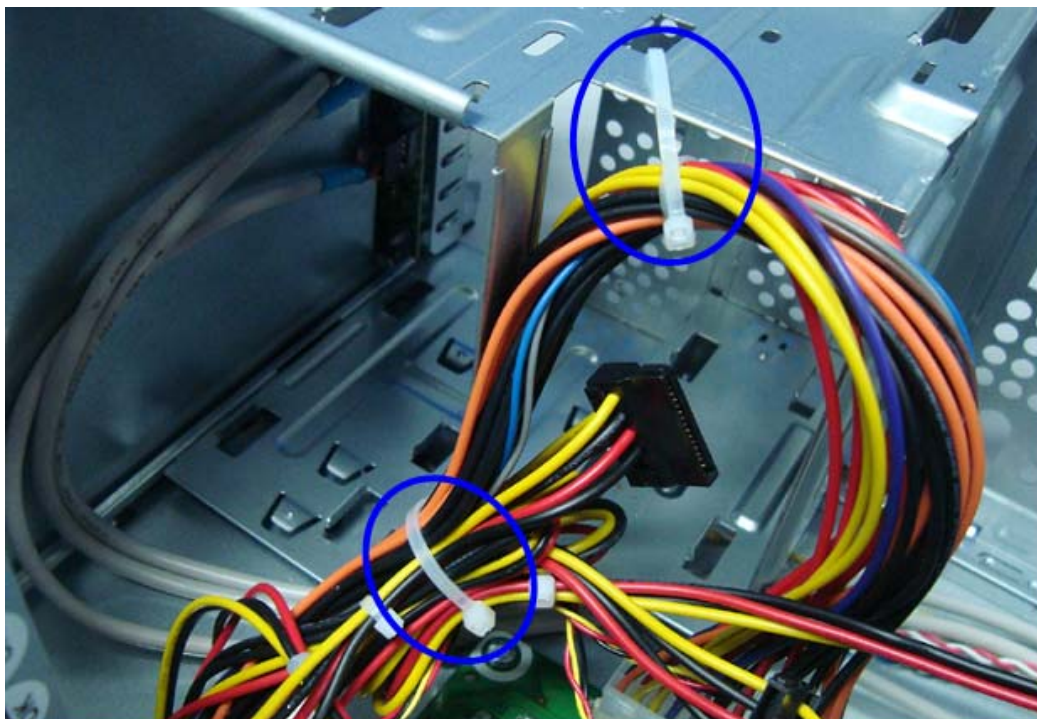

2. Disconnect system FAN cable from main board connector.

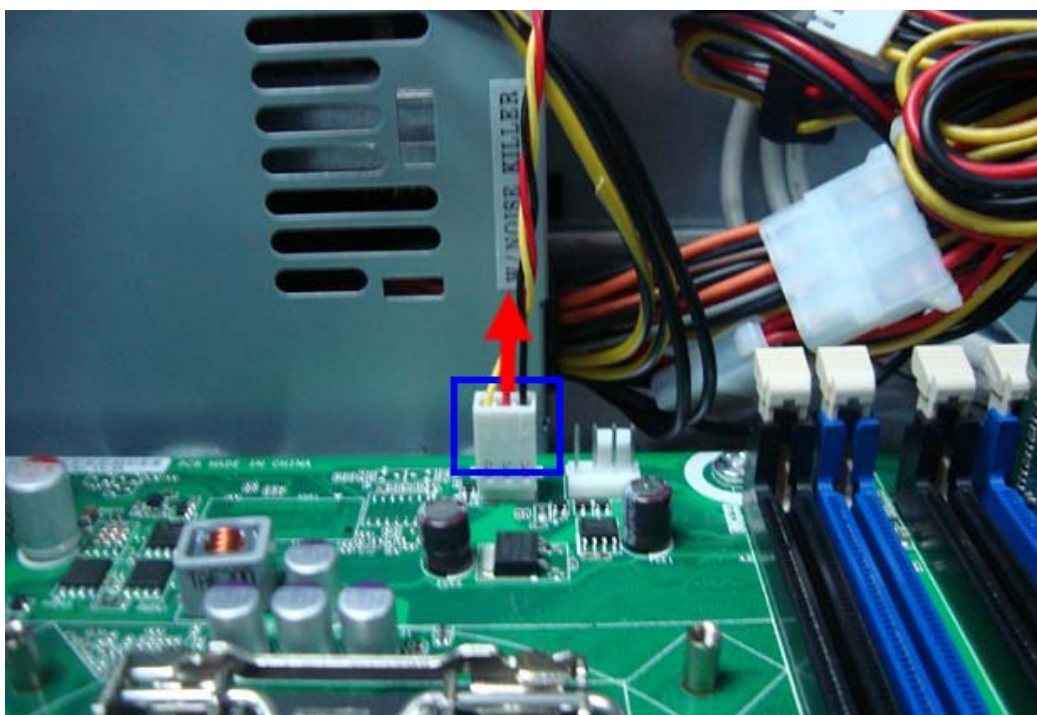

3. Remove the four screws that secure the system fan to the chassis.



4. Remove the system fan from chassis.

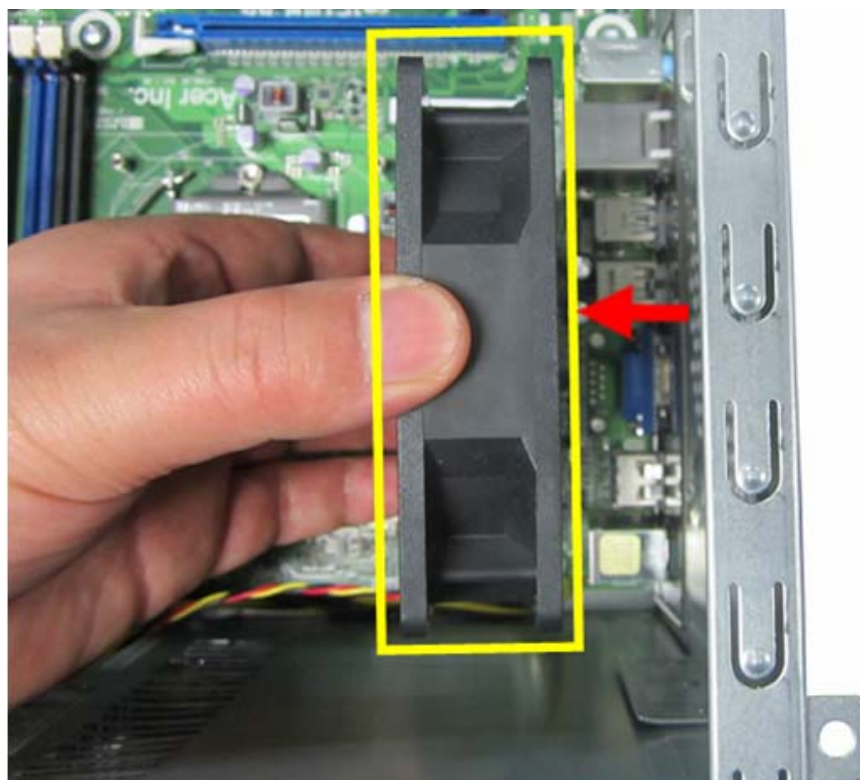

Note: System fan has been highlighted with the yellow rectangle as above image shows. Please detach the system fan and follow local regulations for disposal.

Removing the Power Supply

5. Disconnect the 4-pin and 24-pin power supply cables from the mainboard.

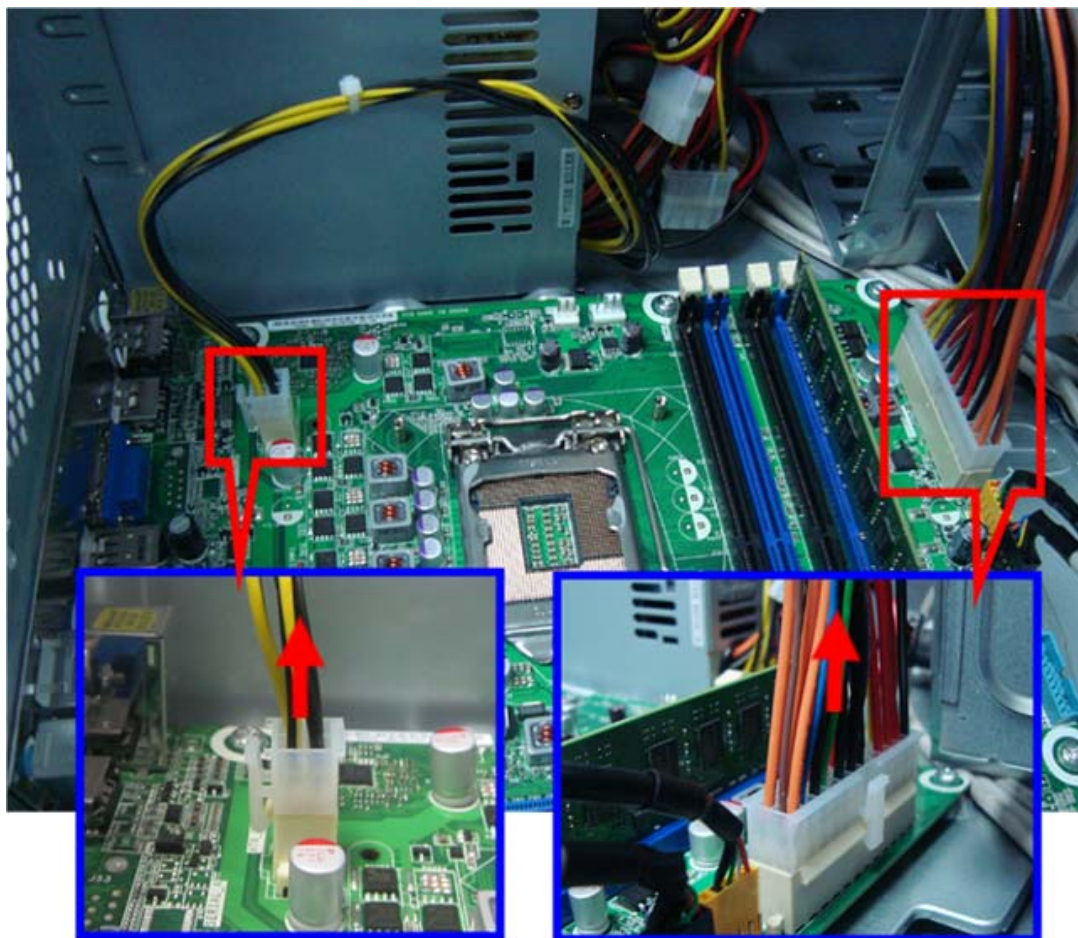

6. Remove the four screws that secures the power supply to the chassis.

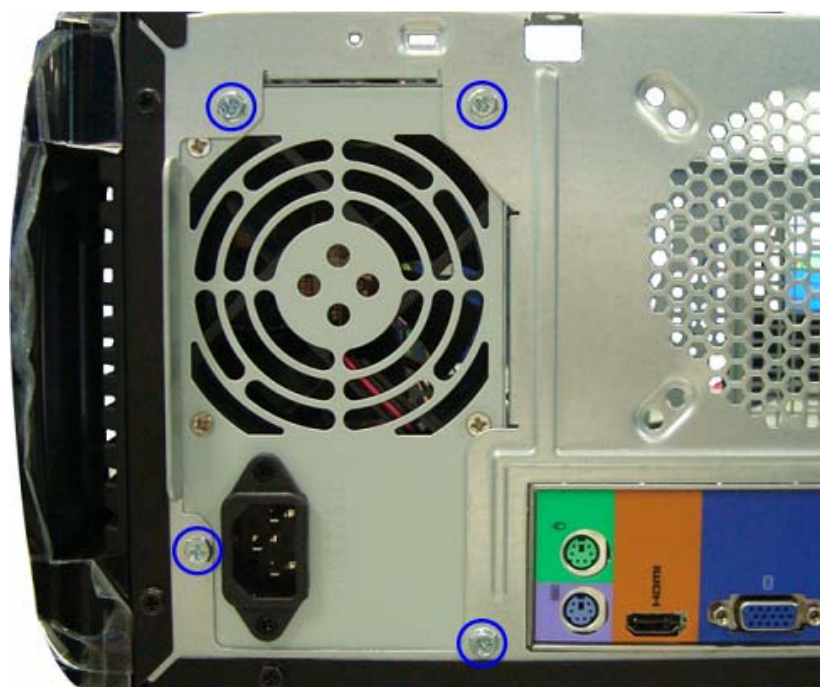

- Lift the power supply module out of the chassis.



Removing the Mainboard

1. Disconnect the front panel cable, front audio cable, USB cable and card reader cable from the main board, then take out the these cables from the cable retention clip.

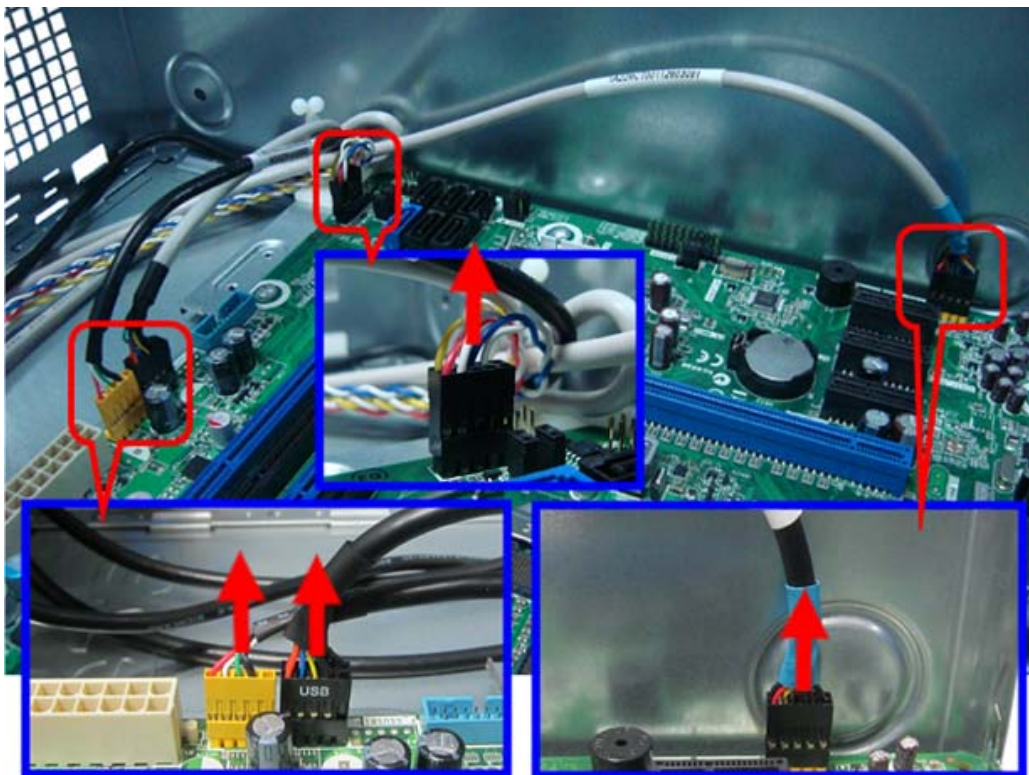

2. Remove the eight screws that secure the mainboard to the chassis.

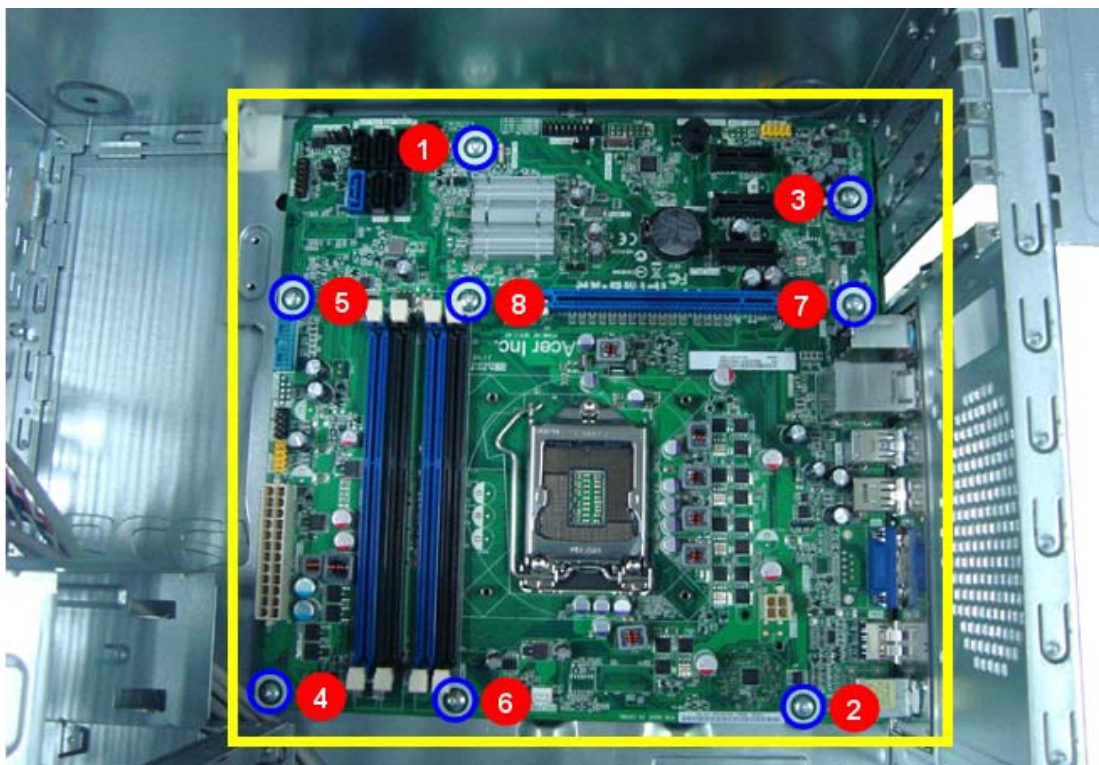

Note: Circuit boards >10 cm² has been highlighted with the yellow rectangle as above image shows.

Please detach the Circuit boards and follow local regulations for disposal.

3. Lift the board from the chassis.

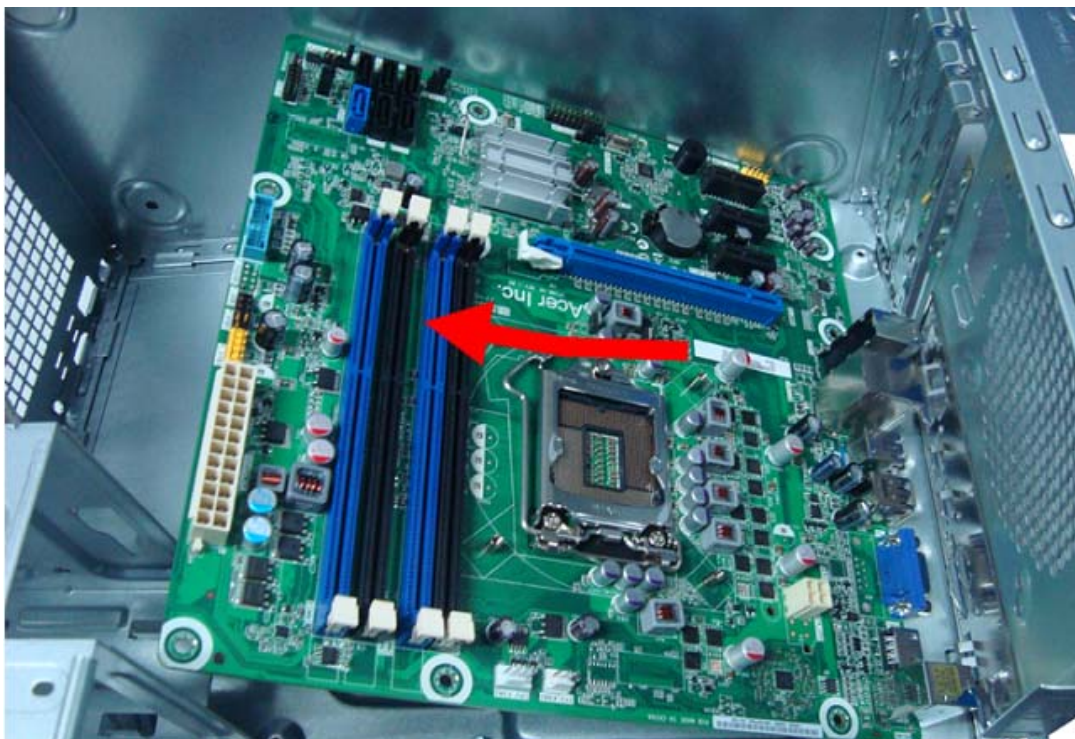

4. Punching in IO Shield then you can remove it.



5. Remove the RTC battery.



Note: RTC battery has been highlighted with the yellow circle as above image shows. Please detach the RTC battery and follow local regulations for disposal.

Removing the Top Cover

1. Remove the rubber, take out power switch cable/top USB cable/card reader USB cable/top audio cable.

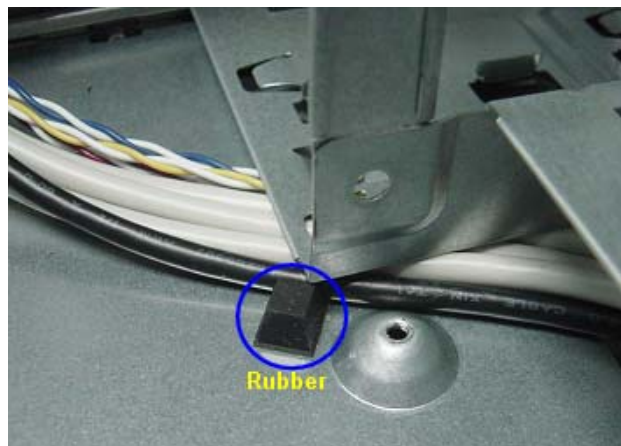

2. Open the cable clip, then take out these cables from cable clip.

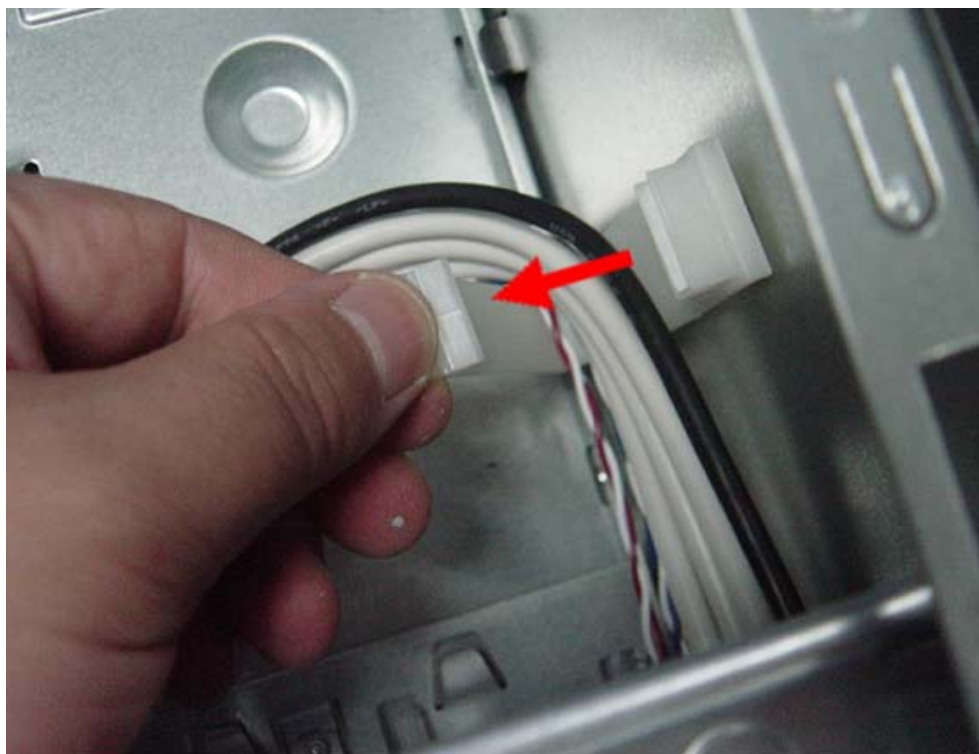

3. Gently release the top bezel retention tabs from the chassis interior.

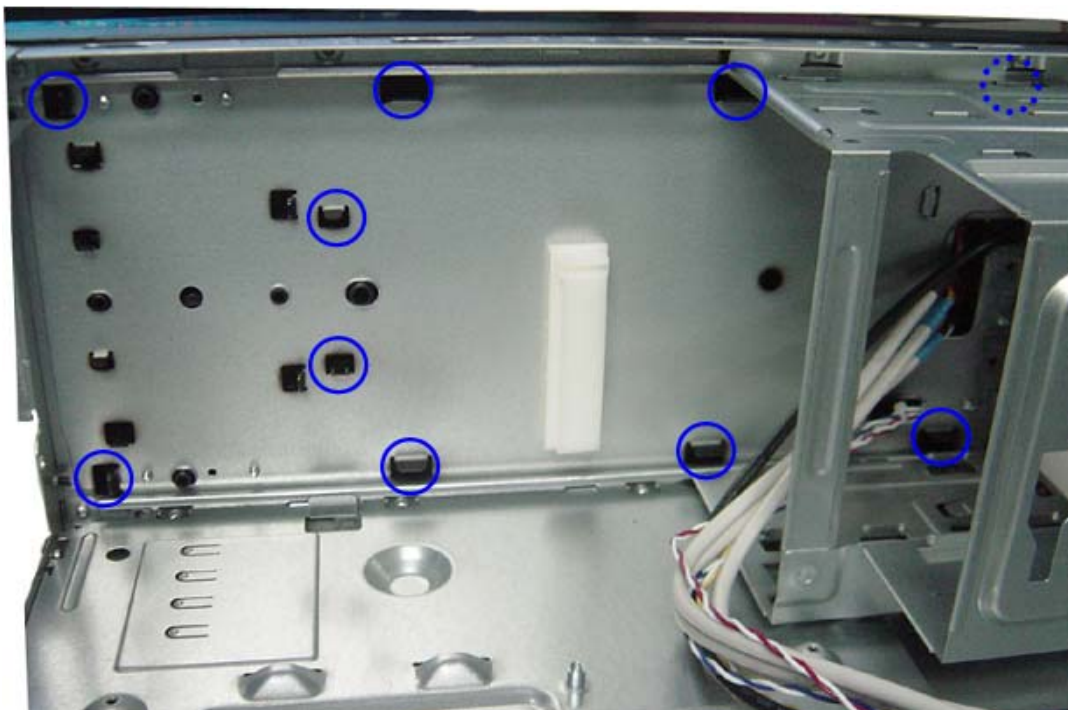

4. Pull the top cover away from the chassis.



Removing the Top USB and Audio I/O Assembly

1. Removing the two screws from the chassis.

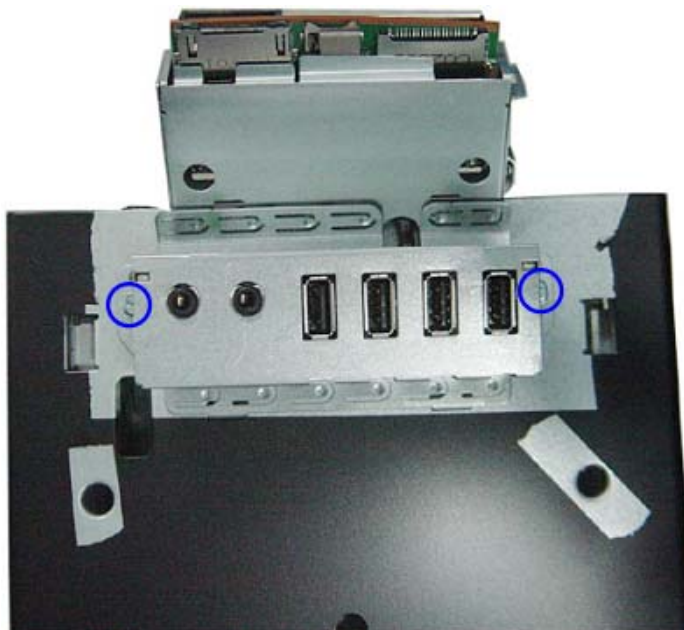

2. Lift the top USB and audio I/O assembly away from chassis.

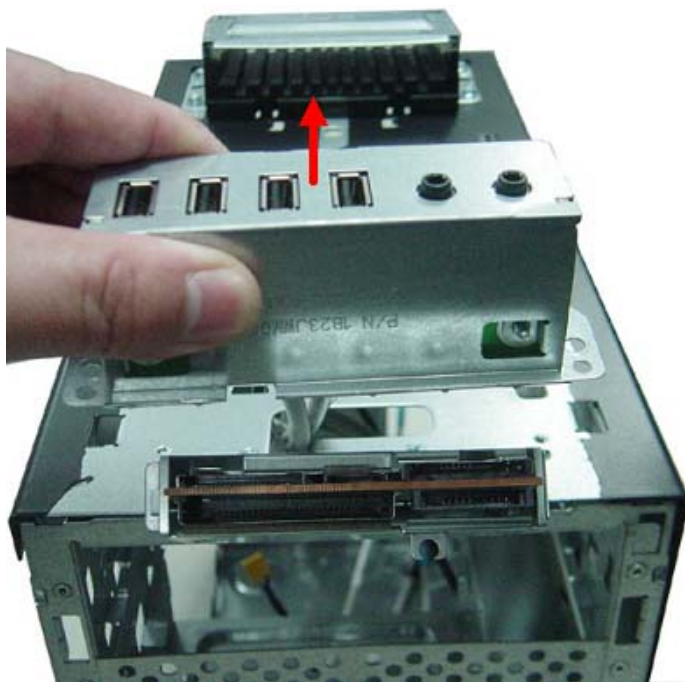

Removing the Card Reader

1. Removing the two screws from the chassis.

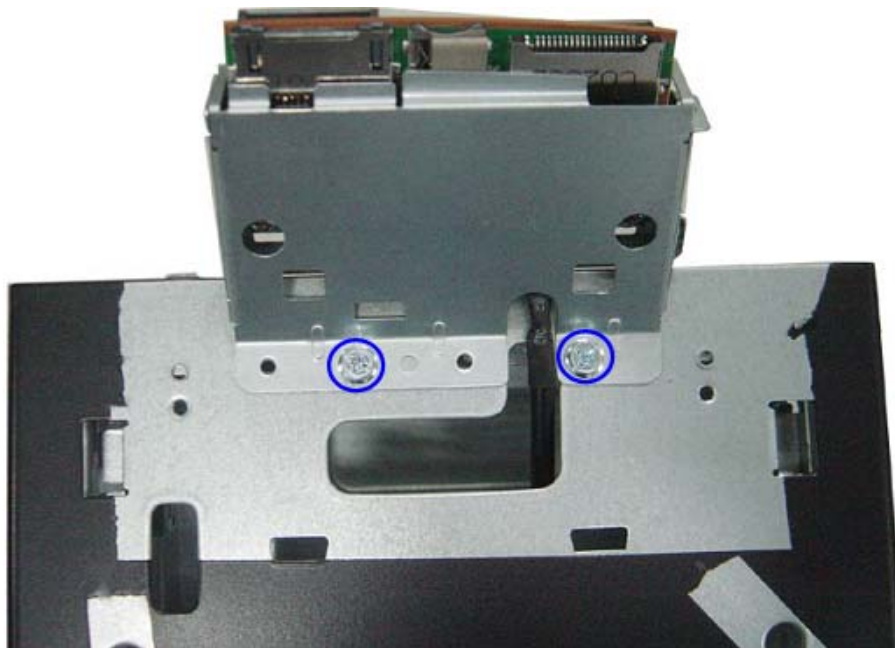

2. Lift the card reader away from chassis.

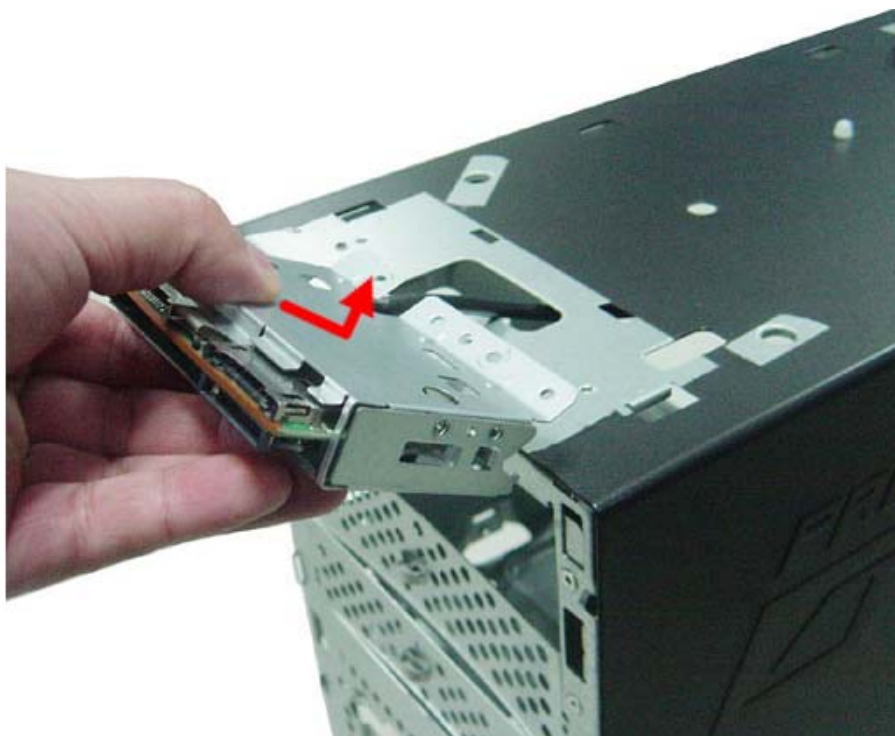

Assembly Requirements

To assemble the computer, you need the following tools:

- Wrist grounding strap and conductive mat for preventing electrostatic discharge
- Flat-blade screwdriver
- Philips screwdriver
- Hex screwdriver
- Plastic flat-blade screwdriver
- Plastic tweezers

NOTE: The screws for the different components vary in size. During the assembly process, group the screws with the corresponding components to avoid mismatch when putting back the components.

Assembly Procedure

Before proceeding with the assembly procedure, perform the steps listed below:

1. Turn off the system and all the peripherals connected to it.
2. Unplug the power cord from the power outlets.
3. Unplug the power cord from the system.
4. Unplug all peripheral cables from the system.
5. Place the system unit on a flat, stable surface.

Removing the Side Panel

1. Remove the four screws located on the rear edge of the side panel.



2. Slide the side panel toward the back of the chassis until the tabs on the cover disengage with the slots on the chassis.
3. Lift the side panel away from the server and put it aside for reinstallation later.



Removing the Cage of Hard Disk Drive

1. Remove the screw that secures the HDD cage to the chassis.



2. Lift the HDD cage up and turn it over.

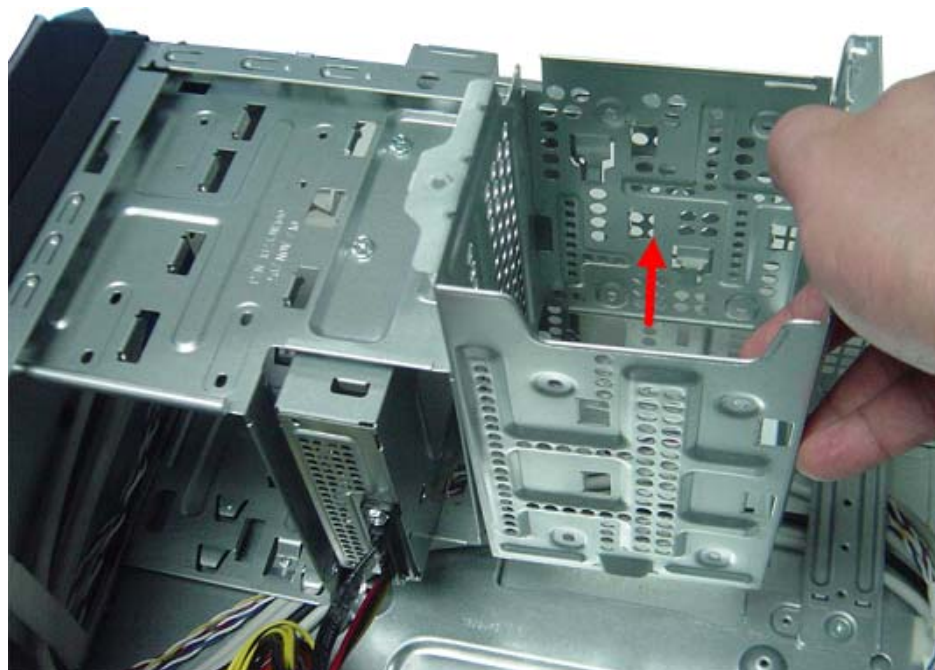

Removing the Bracket of Removable HDD

1. Remove the front bezel.(Refer to "Removing the Front Bezel" on page 28)
2. Remove the three screws.

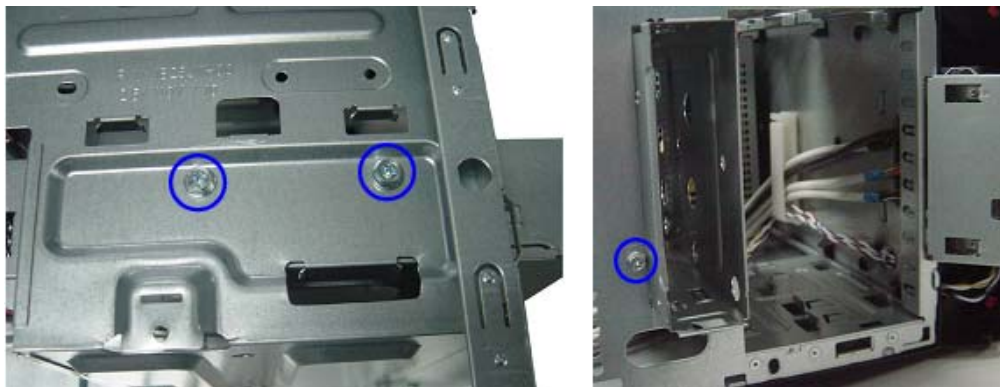

3. Pull the bracket of removable HDD from the chassis.

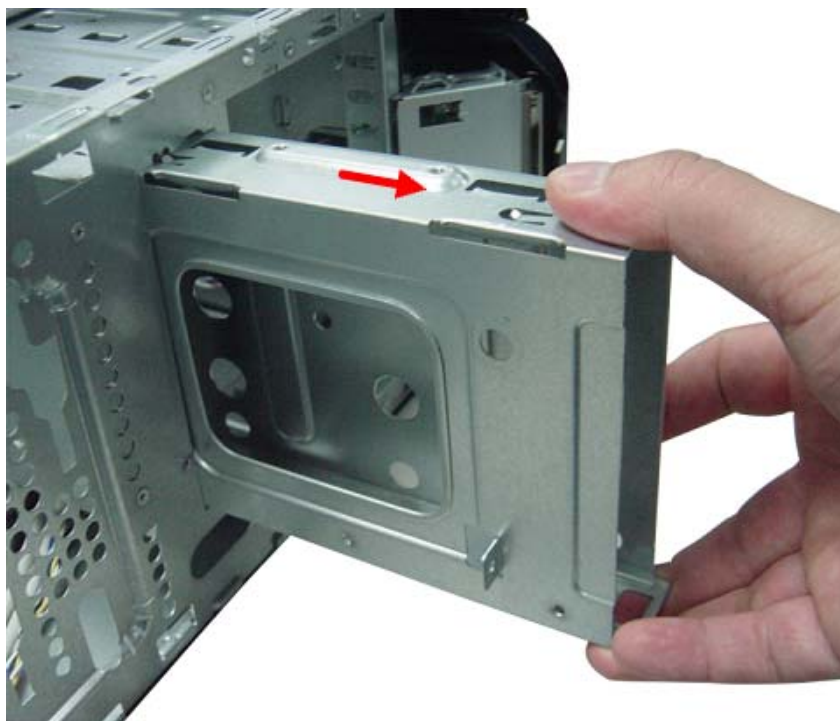

Removing the PCI Cover

1. Remove the PCI cover.

NOTE: Based to actual requirment to remove the PCI cover.



Reinstalling the I/O Shielding

1. Install I/O shielding into chassis.

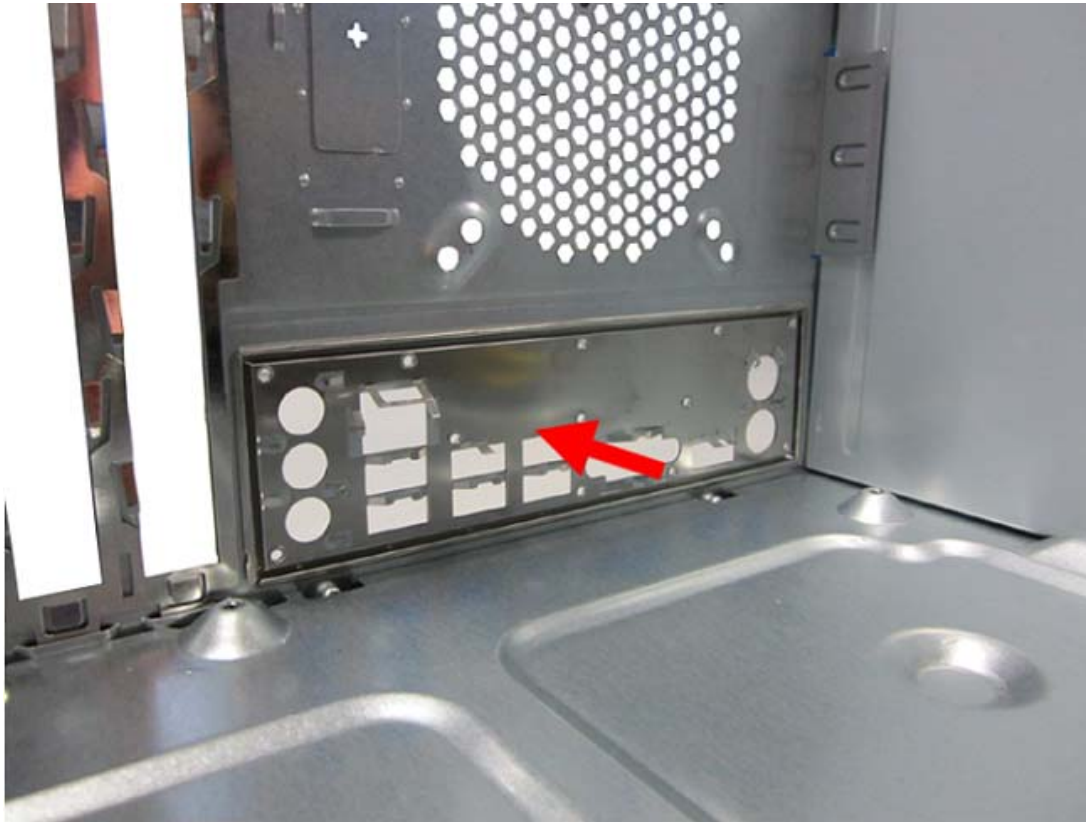

Reinstalling the MainBoard

1. Slide the mainboard into the chassis, with the I/O ports of the mainboard extruding from their port holes, then lower the mainboard in place.

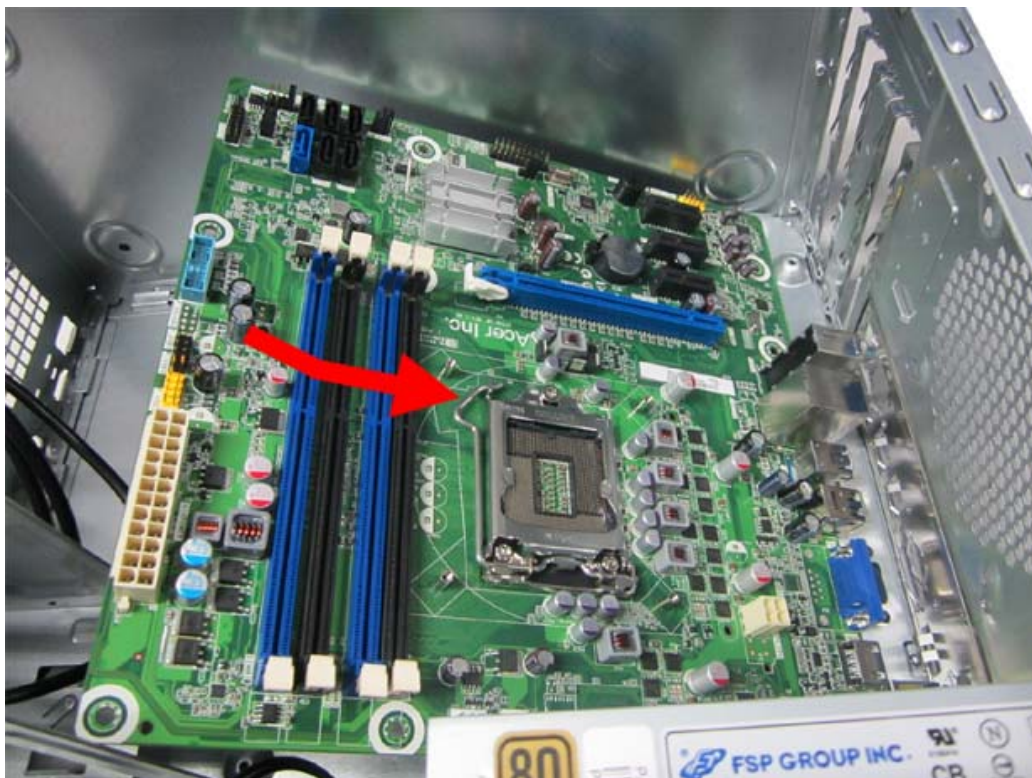

2. Make sure the screw holes on the main board are aligned with those on the chassis. Secure the mainboard with eight screws.

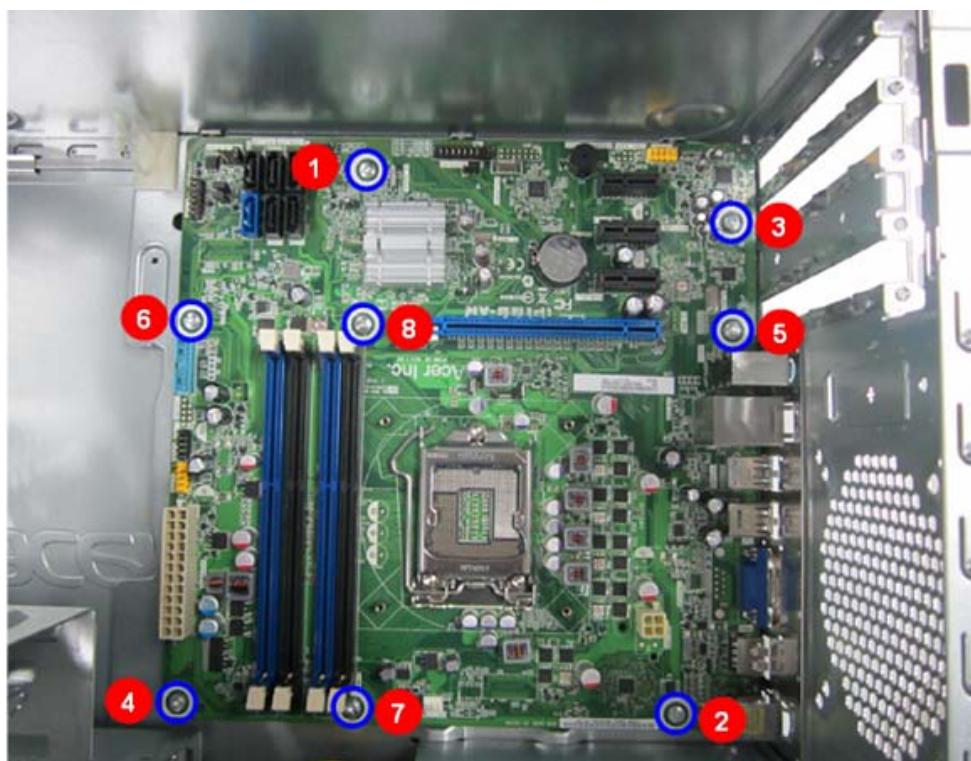

3. Connect the ATX 24Pin Power cable and ATX 4Pin Power cable to main board.

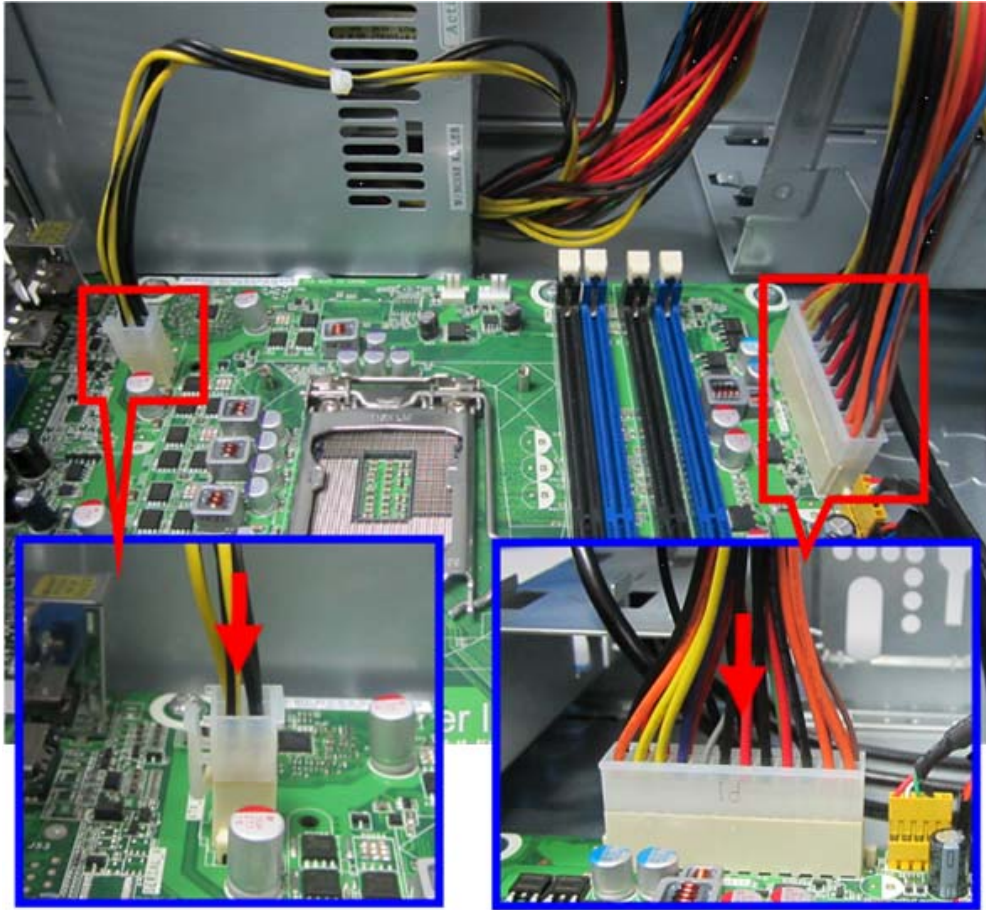

4. Connector the front USB, card reader and front audio cable to motherboard. and put the these cables into the cable retention clip.

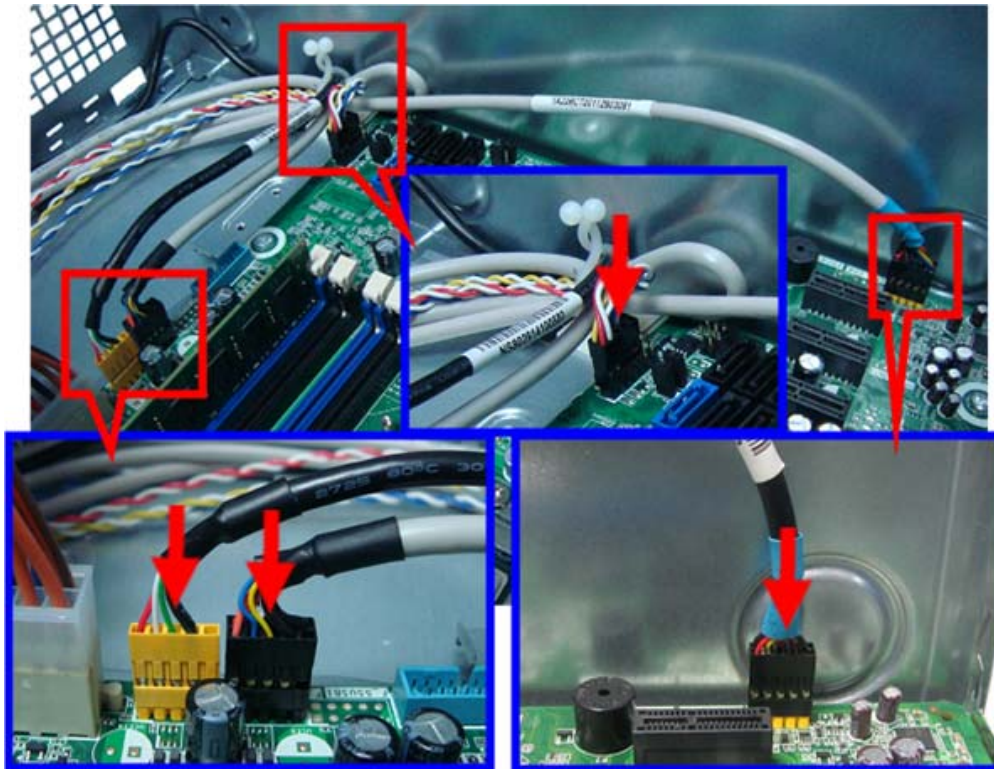

Reinstalling the Optica Drive

1. Install the ODD into the bay.

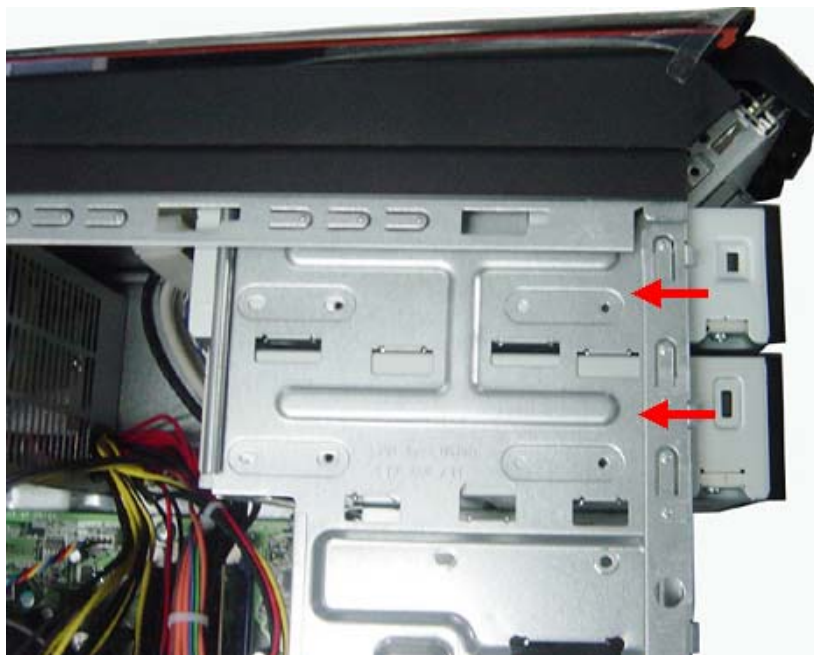

2. Secure the optical drive to the chassis using four screws.



3. Connect the power cables and data cable to the rear of the optical drive.

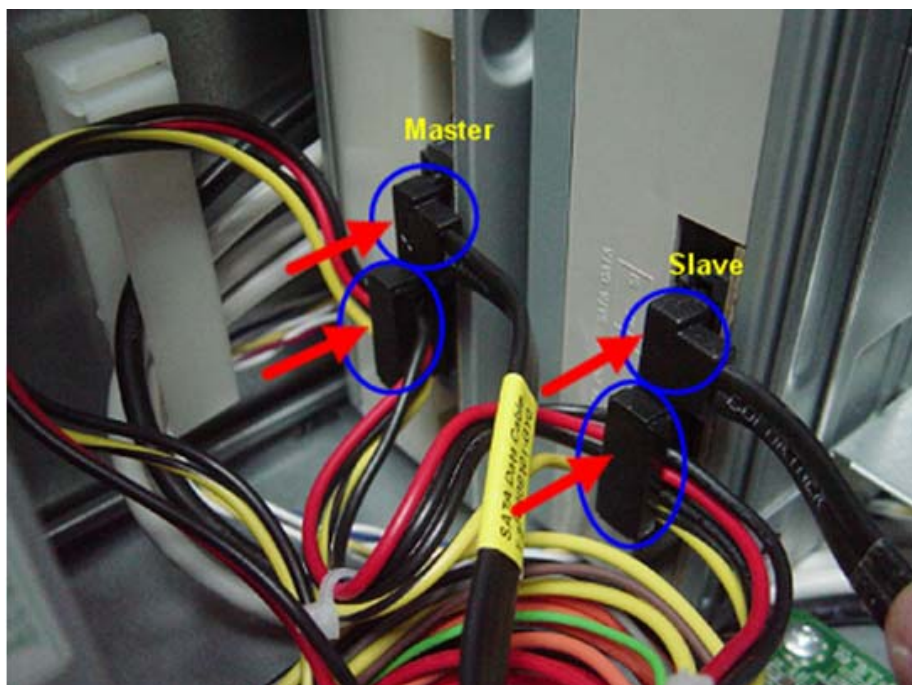

4. Connect the other end of the data cable to the mainboard.

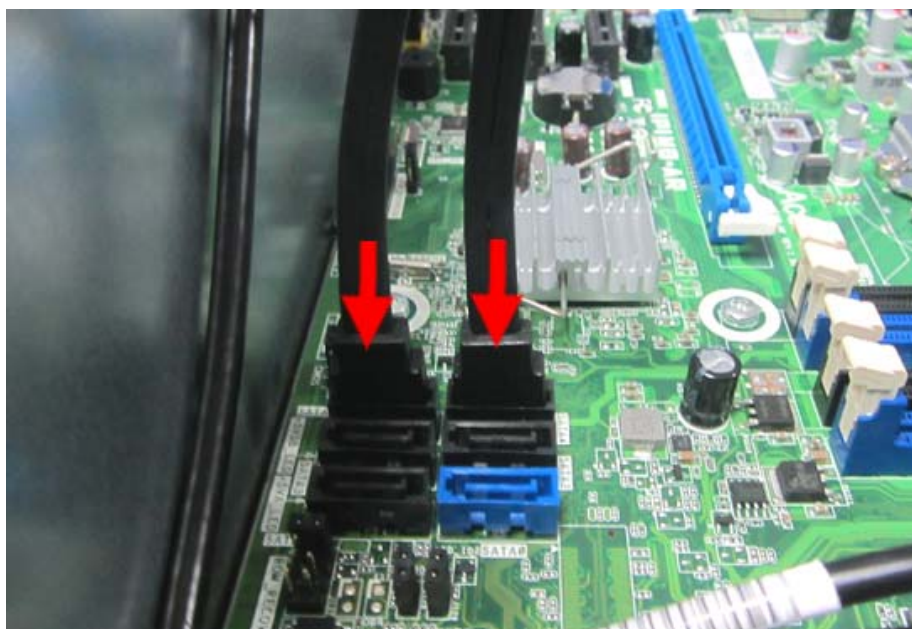

Reinstalling the Bracket of Removable HDD

1. Push the bracket of removable HDD into the chassis.

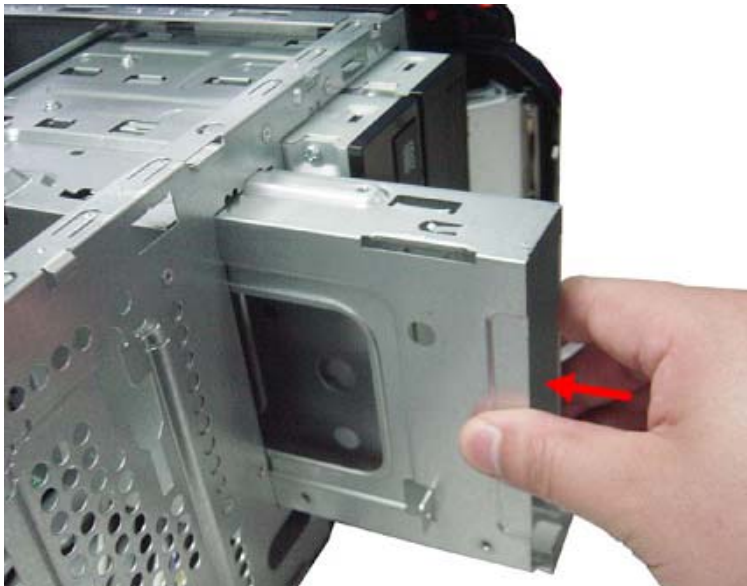

2. Secure the bracket of removable HDD to the chassis using three screws.



Reinstalling the Hard Disk Drive

1. Install the HDD.
 - a. Install the HDD into the cage.



- b. Install other HDD into the cage.



-
- c. Secure the HDD module to the HDD cage using the eight screws.

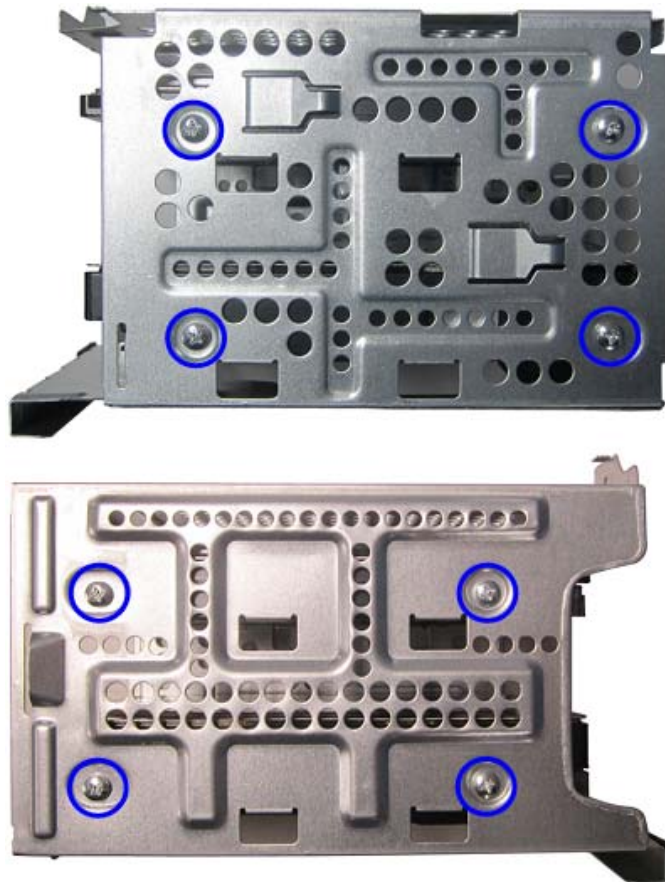

2. Install HDD cage into chassis by the track.

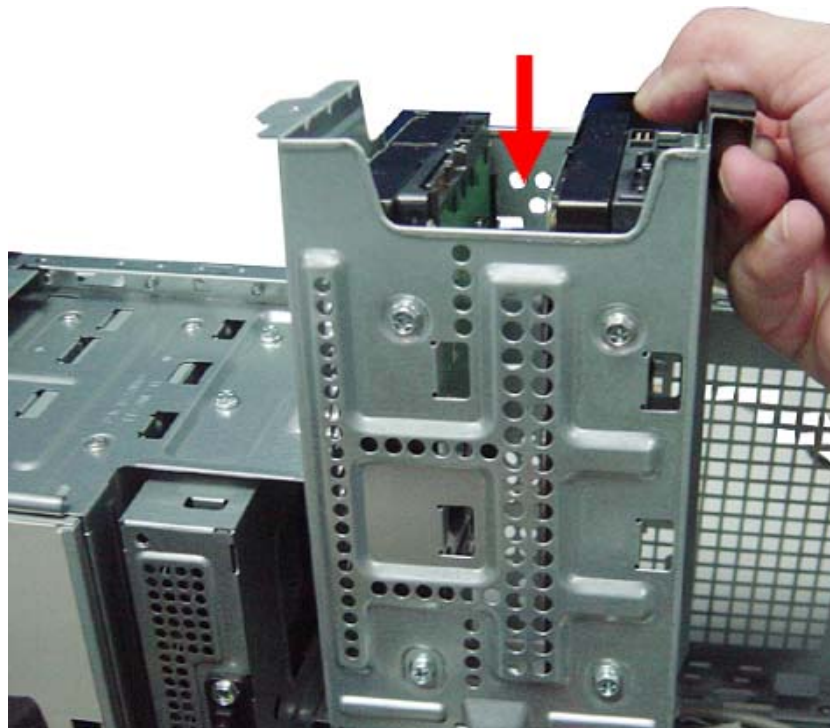

- Secure the bracket of HDD to the chassis using the screws.



- Let the data cable through the bracket.



- Connect the data cable and power cable to the rear of the hard disk drive.

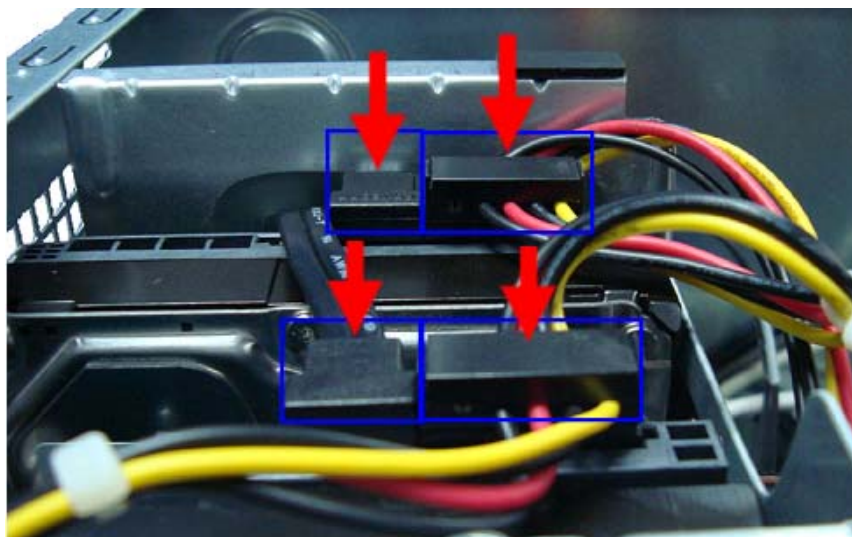

-
6. Connect the other end of the data cable to the main board.

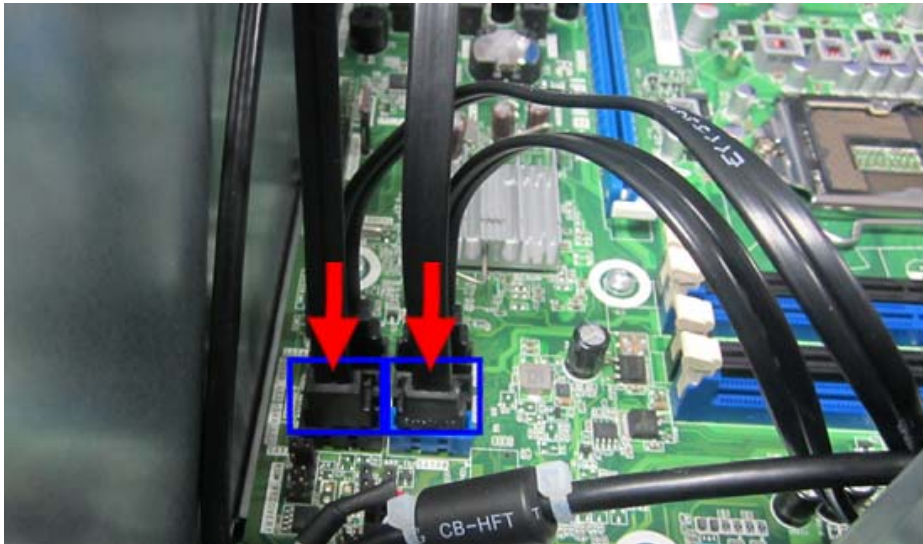

Reinstalling the System Fan

1. Push the system fan to chassis.



2. Fix the four screws.



3. Connect the system fan power cable to Main board.

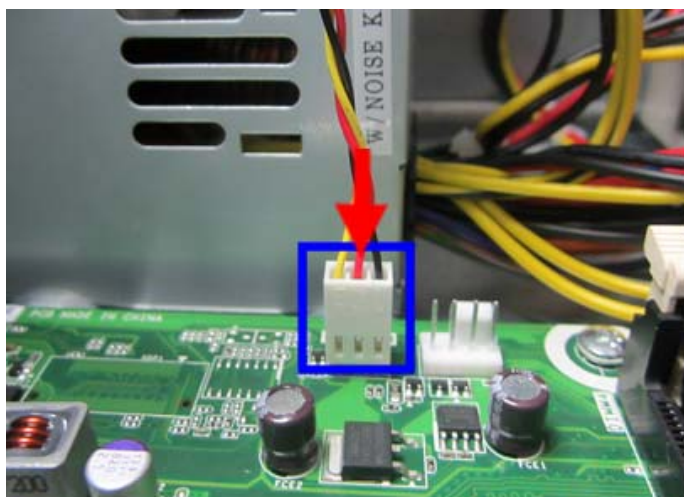

Reinstalling the Memory

1. Open the holding clips on both sides of the DIMM slot outward.

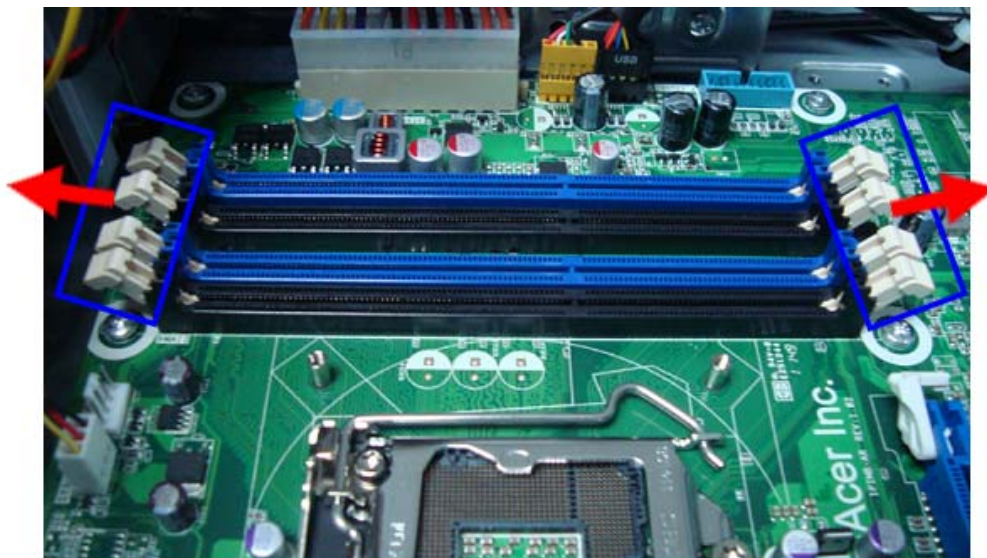

2. Insert the memory module into the DIMM1 slot (1) and then press it down until it clicks into place (2).

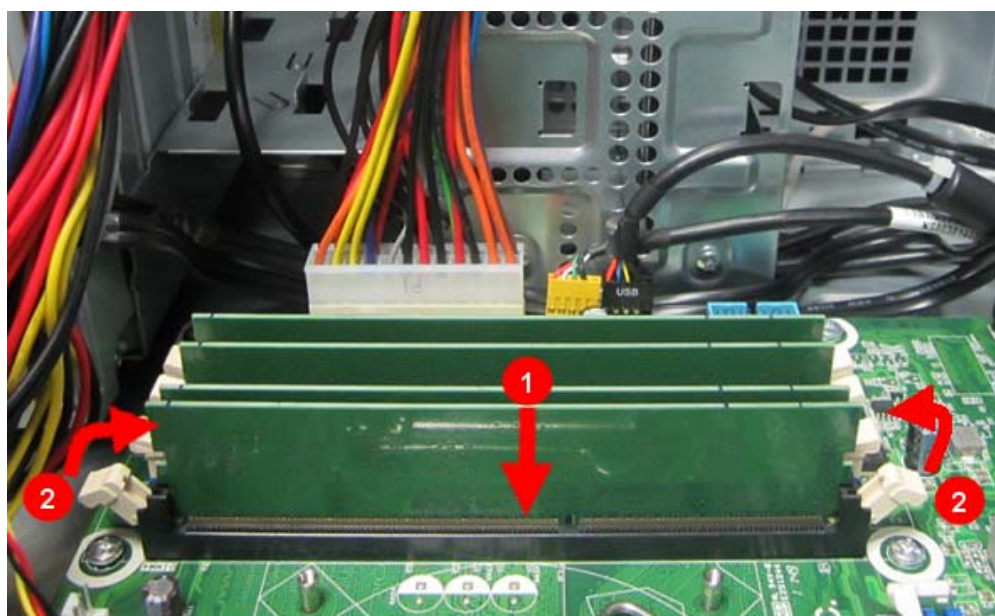

3. If a second memory module is available, install it in the DIMM2 slot by repeating step 1.

Reinstalling the Processor

1. Release the load lever.

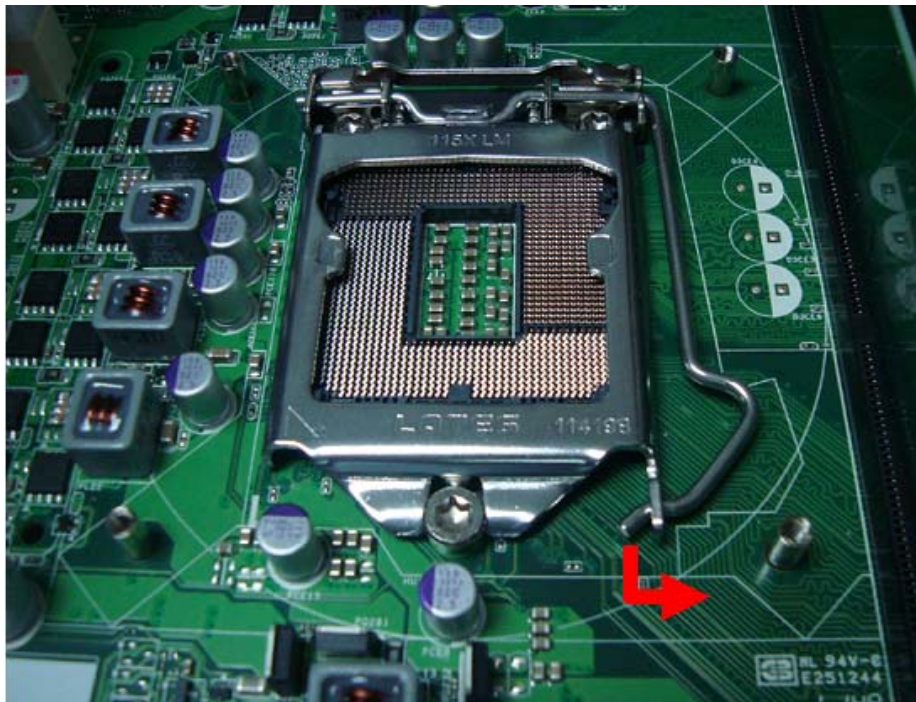

2. Lift the load lever and load plate to the fully open, upright position (1) and (2).

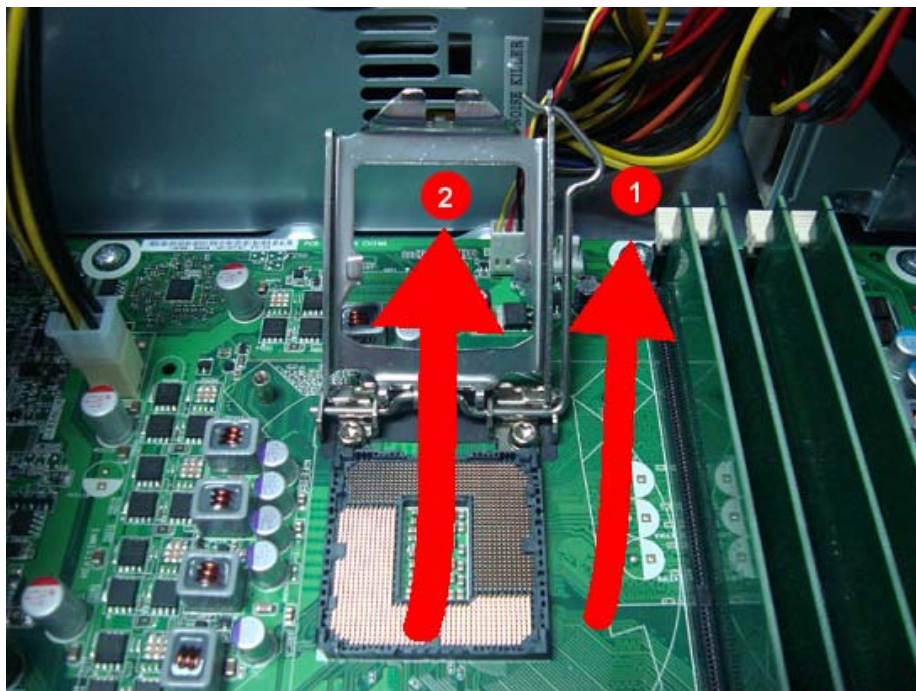

3. Install the processor to the socket.

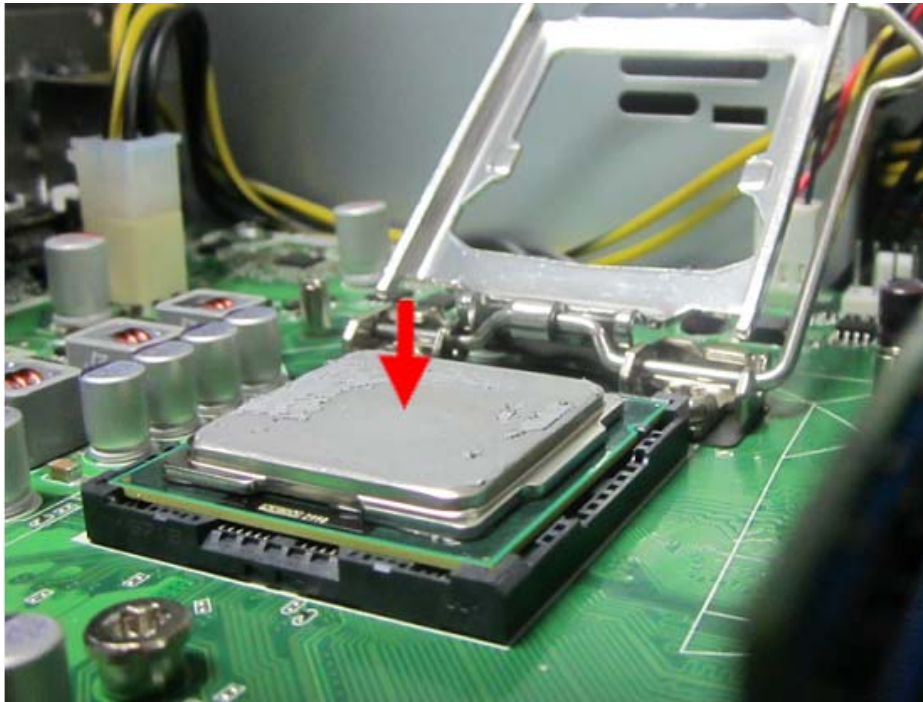

4. Close the load plate and load lever.



NOTE: When you install the processor, note the arrow on the corner to make sure the processor is properly oriented over the socket.



Reinstalling the Heat Sink Fan Assembly

1. Position the heat sink fan assembly on top of the processor, making sure the screws are aligned with the screw holes on the main board.

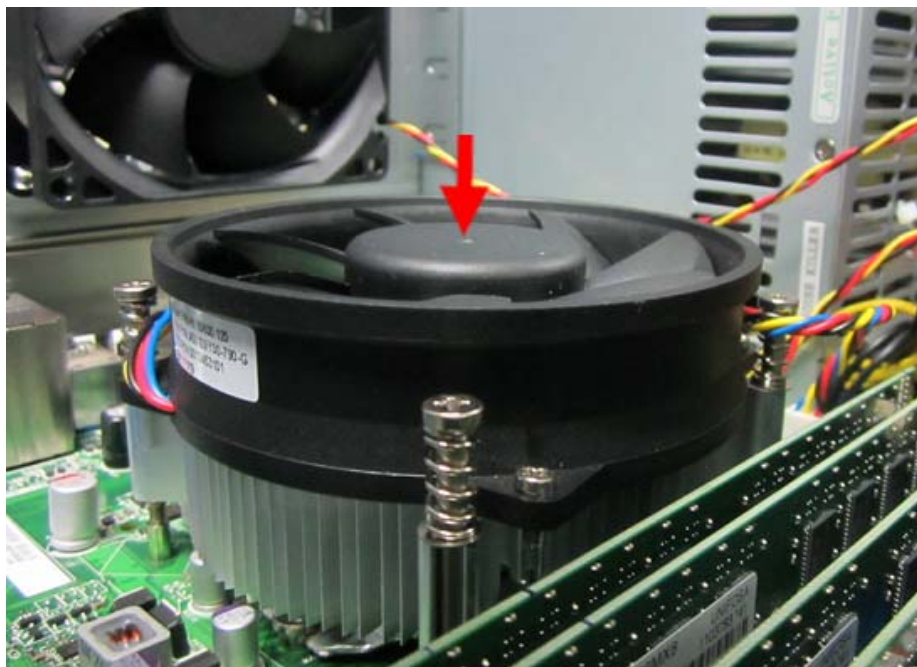

2. Secure the heat sink fan assembly to the screw holes on the main board using four screws.

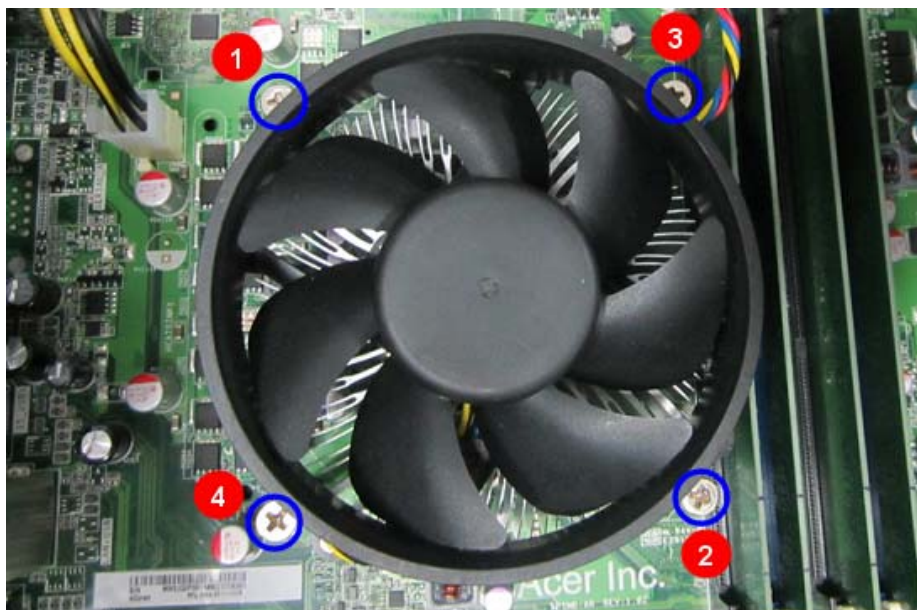

3. Connect the cooler cable to the main board connector.

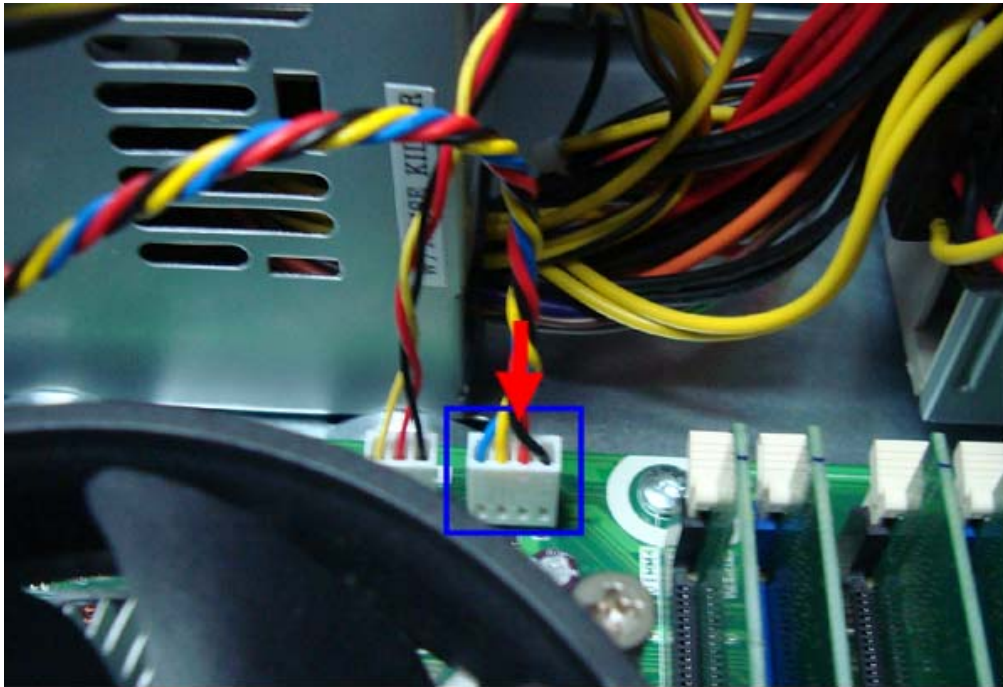

Reinstalling the Modem Card

1. Position the expansion board over the PCIE1X 1 slot and move it slightly to the right (1), making sure the card guide is aligned with the slot guide on the chassis. Insert the expansion card connector properly into PCIE1X 1 slot (2).

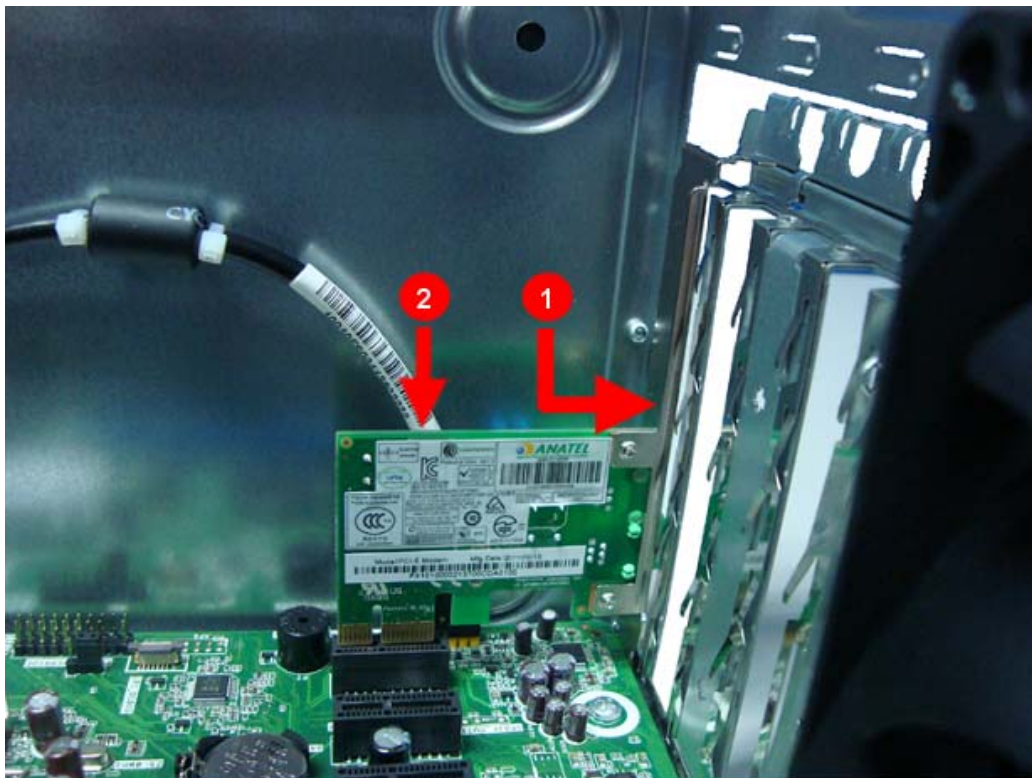

Reinstalling the Wireless Lan Card

1. Position the expansion board over the PCIE1X 1 slot and move it slightly to the right (1), making sure the card guide is aligned with the slot guide on the chassis. Insert the expansion card connector properly into PCIE1X 1 slot (2).

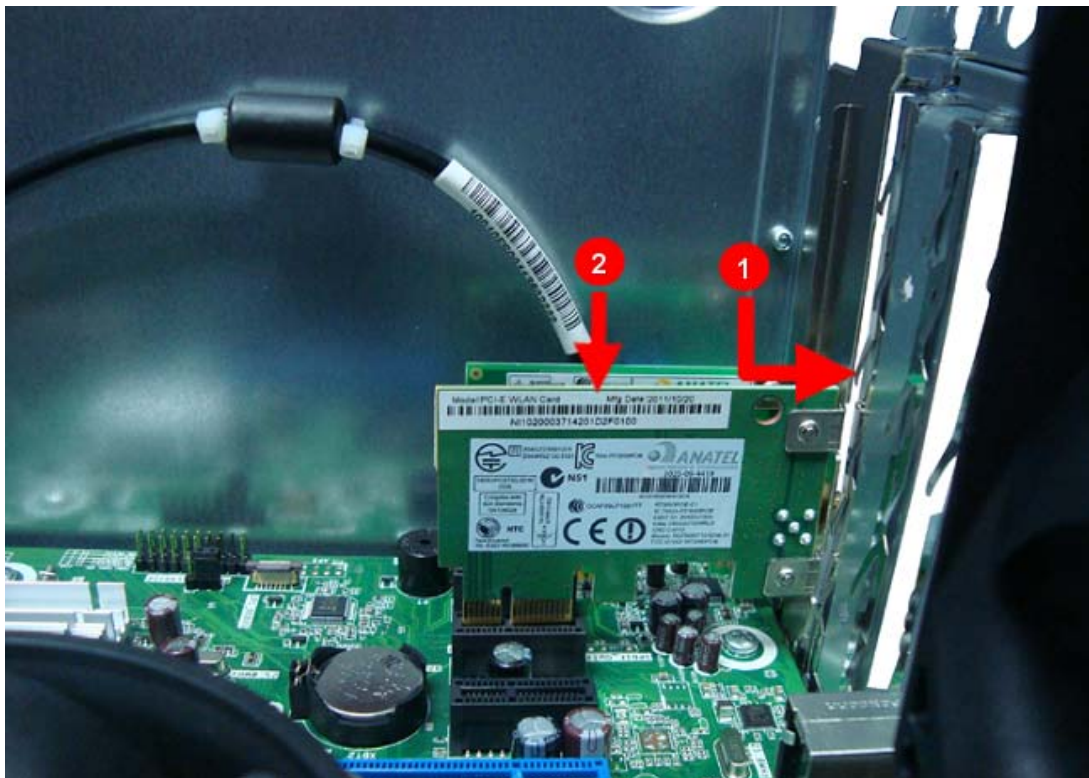

Reinstalling the VGA Card

1. Position the expansion board over the PCIE16X 1 slot and move it slightly to the right (1), making sure the card guide is aligned with the slot guide on the chassis. Insert the expansion card properly connector into PCIE16X 1 slot (2).

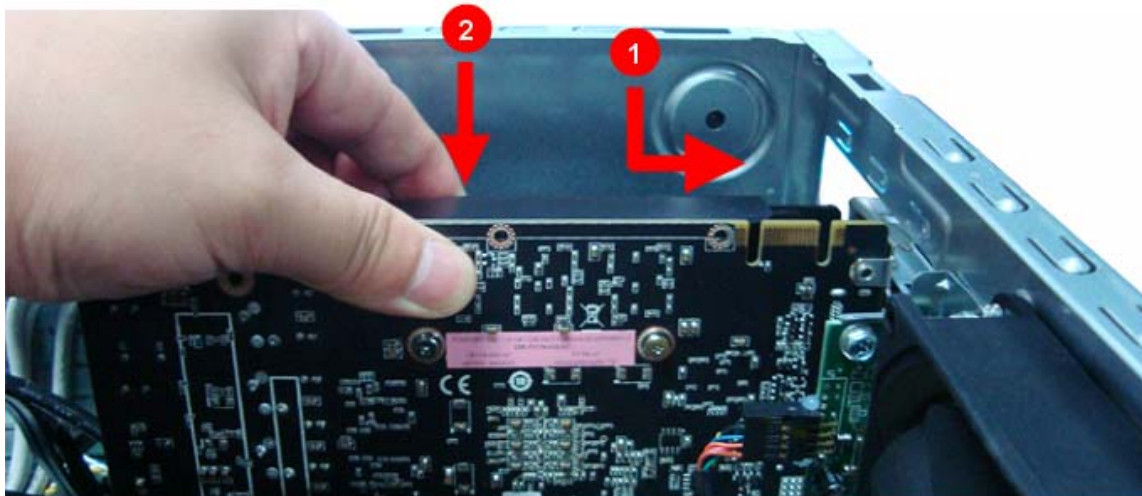

2. Connector the power cable to the VGA card.

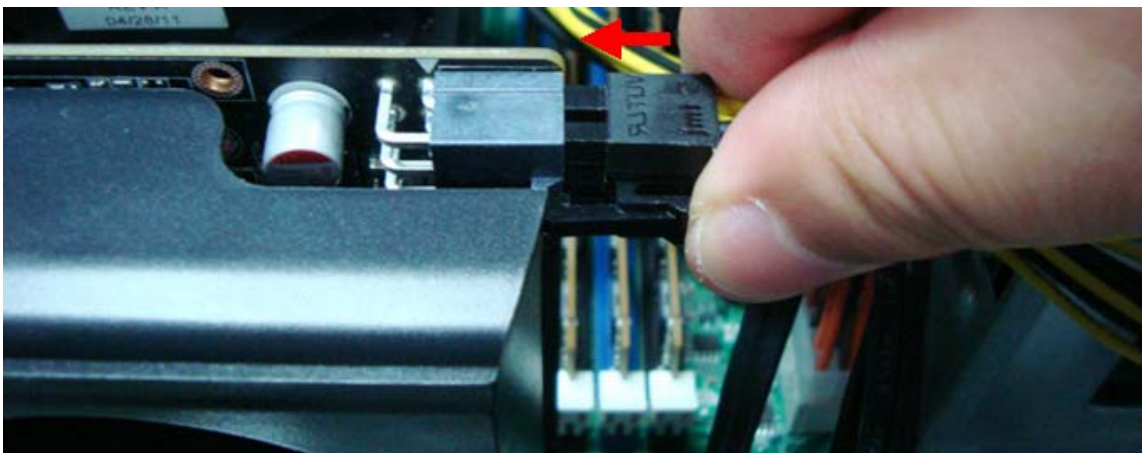

3. Close the PCI Latch, fix the three screws.

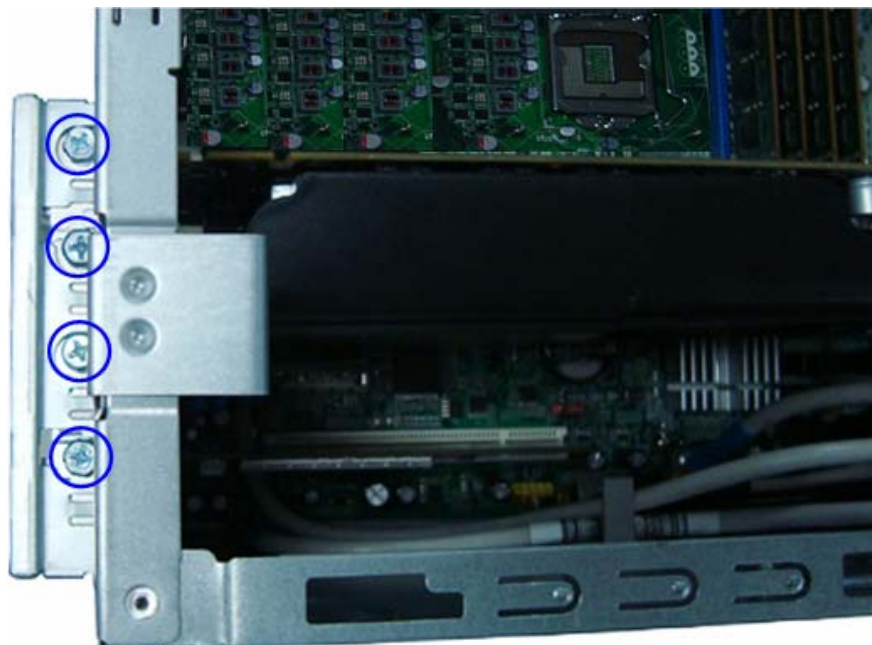

Reinstalling the Front Bezel

1. Take 2PCS cable tying, use cable tying to bundle PSU power cables & system FAN power cable, and use other 1pc cable tying to bundle PSU power cables & System FAN power cable on bracket.

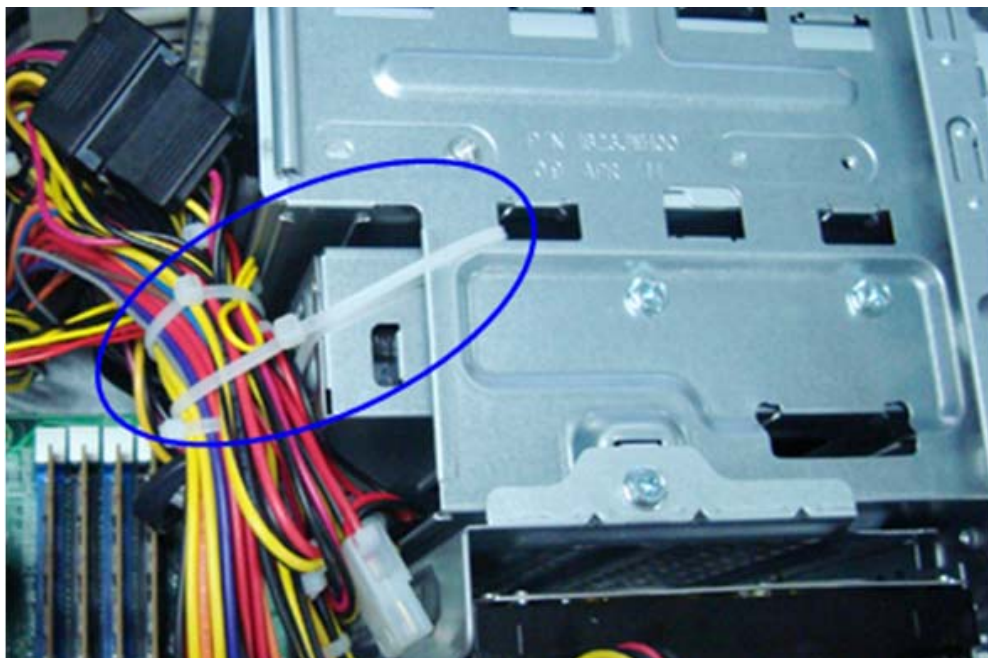

2. Install the panel onto chassis and then check if it is Installed OK.



Reinstalling the Side Panel

1. Install the side Panel, then fix two screws.



System Troubleshooting

This chapter provides instructions on how to troubleshoot system hardware problems.

Hardware Diagnostic Procedure

IMPORTANT: The diagnostic tests described in this chapter are only intended to test Acer products. Non-Acer products, prototype cards, or modified options can give false errors and invalid system responses.

1. Obtain the failing symptoms in as much detail as possible.
2. Verify the symptoms by attempting to recreate the failure by running the diagnostic tests or repeating the same operation.
3. Refer to “Power System check” on page 85 and “Beep Codes” on page 86 to determine which corrective action to perform.

System Check Procedures

Power System Check

If the system will power on, skip this section. Refer to System External Inspection.

If the system will not power on, do the following:

- Check if the power cable is properly connected to the system and AC source.
- Check if the voltage selector switch is set to the correct voltage setting.

System External Inspection

1. Inspect the LED indicators on the front panel, which can indicate the malfunction.
2. Make sure that air flow is not blocked.
3. Make sure nothing in the system is making contact that could short out power.
4. If the problem is not evident, continue with System Internal Inspection.

System Internal Inspection

1. Turn off the system and all the peripherals connected to it.
2. Unplug the power cord from the power outlets.
3. Unplug the power cord from the system.
4. Unplug all peripheral cables from the system.
5. Place the system unit on a flat, stable surface.
6. Remove the system covers. For instructions on removing system covers, refer to "System Disassembly" on page 25.
7. Verify that components are properly seated.
8. Verify that all cable connectors inside the system are firmly and correctly attached to their appropriate connectors.
9. Verify that all components are Acer-qualified and supported.
10. Replace the system covers.
11. Power on the system.
12. If the problem with the system is not evident, you can try viewing the POST messages and BIOS event logs during the system startup.

Beep Codes

Beep codes are used by the BIOS to indicate a serious or fatal error to the end user. Beep codes are used when an error occurs before the system video has been initialized. Beep codes will be generated by the system board speaker, commonly referred to as the PC speaker.

AMIBIOS displays the checkpoints in the bottom right corner of the screen during POST. This display method is limited, since it only displays checkpoints that occur after the video card has been activated.

Not all computers using AMIBIOS enable this feature. In most cases, a checkpoint card is the best tool for viewing AMIBIOS checkpoints.

Beep Symptom	Cause and Description
One short beep	System is ready. System is OK.
Continuous one long beep	Memory not installed or memory error.
One long beep and two short beeps then repeat.	VGA not installed or VGA error. Graphics card error/not installed, graphics card memory error or graphics card BIOS checksum error.
One long beep then two short beep	BIOS damaged. BIOS is damaged, BIOS POST jumps to Boot Block to execute the default procedures.
Two short beeps	CMOS damaged. CMOS checksum error or CMOS battery loss occurs.

Checkpoints

A checkpoint is either a byte or word value output to I/O port 80h. The BIOS outputs checkpoints throughout bootblock and Power-On Self Test (POST) to indicate the task the system is currently executing. Checkpoints are very useful in aiding software developers or technicians in debugging problems that occur during the pre-boot process.

Viewing BIOS checkpoints

Viewing all checkpoints generated by the BIOS requires a checkpoint card, also referred to as a POST card or POST diagnostic card. These are ISA or PCI add-in cards that show the value of I/O port 80h on a LED display. Checkpoints may appear on the bottom right corner of the screen during POST. This display method is limited, since it only displays checkpoints that occur after the video card has been activated.

Bootblock Initialization Code Checkpoints

The Bootblock initialization code sets up the chipset, memory, and other components before system memory is available. The following table describes the type of checkpoints that may occur during the bootblock initialization portion of the BIOS.

NOTE: Please note that checkpoints may differ between different platforms based on system configuration. Checkpoints may change due to vendor requirements, system chipset or option ROMs from add-in PCI devices.

Checkpoint	Description
Before D0	If boot block debugger is enabled, CPU cache-as-RAM functionality is enabled at this point. Stack will be enabled from this point.
D0	Early Boot Strap Processor (BSP) initialization like microcode update, frequency and other CPU critical initialization. Early chipset initialization is done.
D1	Early super I/O initialization is done including RTC and keyboard controller. Serial port is enabled at this point if needed for debugging. NMI is disabled. Perform keyboard controller BAT test. Save power-on CPUID value in scratch CMOS. Go to flat mode with 4GB limit and GA20 enabled.
D2	Verify the boot block checksum. System will hang here if checksum is bad.
D3	Disable CACHE before memory detection. Execute full memory sizing module. If memory sizing module not executed, start memory refresh and do memory sizing in Boot block code. Do additional chipset initialization. Re-enable CACHE. Verify that flat mode is enabled.
D4	Test base 512KB memory. Adjust policies and cache first 8MB. Set stack.
D5	Bootblock code is copied from ROM to lower system memory and control is given to it. BIOS now executes out of RAM. Copies compressed boot block code to memory in right segments. Copies BIOS from ROM to RAM for faster access. Performs main BIOS checksum and updates recovery status accordingly.
D6	Both key sequence and OEM specific method is checked to determine if BIOS recovery is forced. Main BIOS checksum is tested. If BIOS recovery is necessary, control flows to checkpoint E0. See Bootblock Recovery Code Checkpoints section for more information.
D7	Restore CPUID value back into register. The Bootblock-Runtime interface module is moved to system memory and control is given to it. Determine whether to execute serial flash.
D8	The Runtime module is uncompressed into memory. CPUID information is stored in memory.
D9	Store the Uncompressed pointer for future use in PMM. Copying Main BIOS into memory. Leaves all RAM below 1MB Read-Write including E000 and F000 shadow areas but closing SMRAM.

Checkpoint	Description
DA	Restore CPUID value back into register. Give control to BIOS POST (ExecutePOSTKernel). See POST Code Checkpoints section of document for more information.
DC	System is waking from ACPI S3 state.
E1-E8 EC-EE	OEM memory detection/configuration error. This range is reserved for chipset vendors & system manufacturers. The error associated with this value may be different from one platform to the next.

Bootblock Recovery Code Checkpoints

The Bootblock recovery code gets control when the BIOS determines that a BIOS recovery needs to occur because the user has forced the update or the BIOS checksum is corrupt. The following table describes the type of checkpoints that may occur during the Bootblock recovery portion of the BIOS.

NOTE: Checkpoints may differ between different platforms based on system configuration. Checkpoints may change due to vendor requirements, system chipset or option ROMs from add-in PCI devices.

Checkpoint	Description
E0	Initialize the floppy controller in the super I/O. Some interrupt vectors are initialized. DMA controller is initialized. 8259 interrupt controller is initialized. L1 cache is enabled.
E9	Set up floppy controller and data. Attempt to read from floppy.
EA	Enable ATAPI hardware. Attempt to read from ARMD and ATAPI CDROM.
EB	Disable ATAPI hardware. Jump back to checkpoint E9.
EF	Read error occurred on media. Jump back to checkpoint EB.
F0	Search for pre-defined recovery file name in root directory.
F1	Recovery file not found.
F2	Start reading FAT table and analyze FAT to find the clusters occupied by the recovery file.
F3	Start reading the recovery file cluster by cluster.
F5	Disable L1 cache.
FA	Check the validity of the recovery file configuration to the current configuration of the flash part.
FB	Make flash write enabled through chipset and OEM specific method. Detect proper flash part. Verify that the found flash part size equals the recovery file size.
F4	The recovery file size does not equal the found flash part size.
FC	Erase the flash part
FD	Program the flash part.
FF	The flash has been updated successfully. Make flash write disabled. Disable ATAPI hardware. Restore CPUID value back into register. Give control to F000 ROM at F000:FFF0h.

BIOS Recovery

1. The usage of recovery boot block:
 - Please re-name BIOS ROM (xxxx.ROM or 2MB size ROM) file to "AMIBOOT.ROM" and burn in BIOS ROM file to CDROM or copy BIOS ROM file to USB Thumb drive.
2. Automatic mode:
 - When BIOS flash crashed, using recovery CDROM/USB Thumb drive to recover BIOS.
3. Recovery Menu and Step:
 - a. Before recovering BIOS, please change "Reset NVRAM" item form "Enabled" to "Disabled".

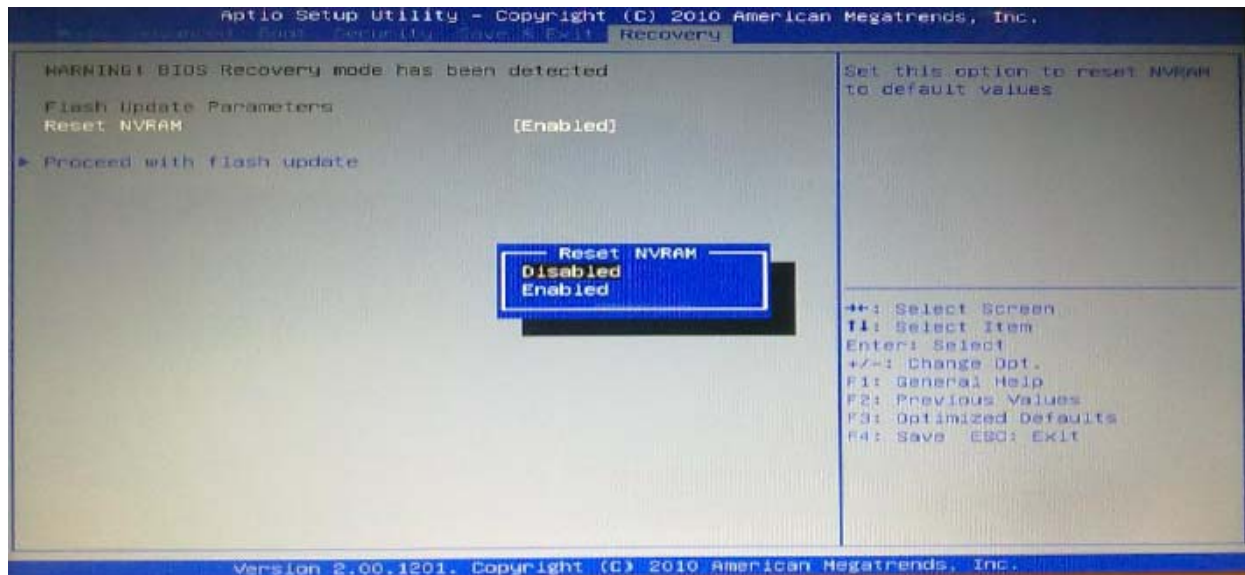
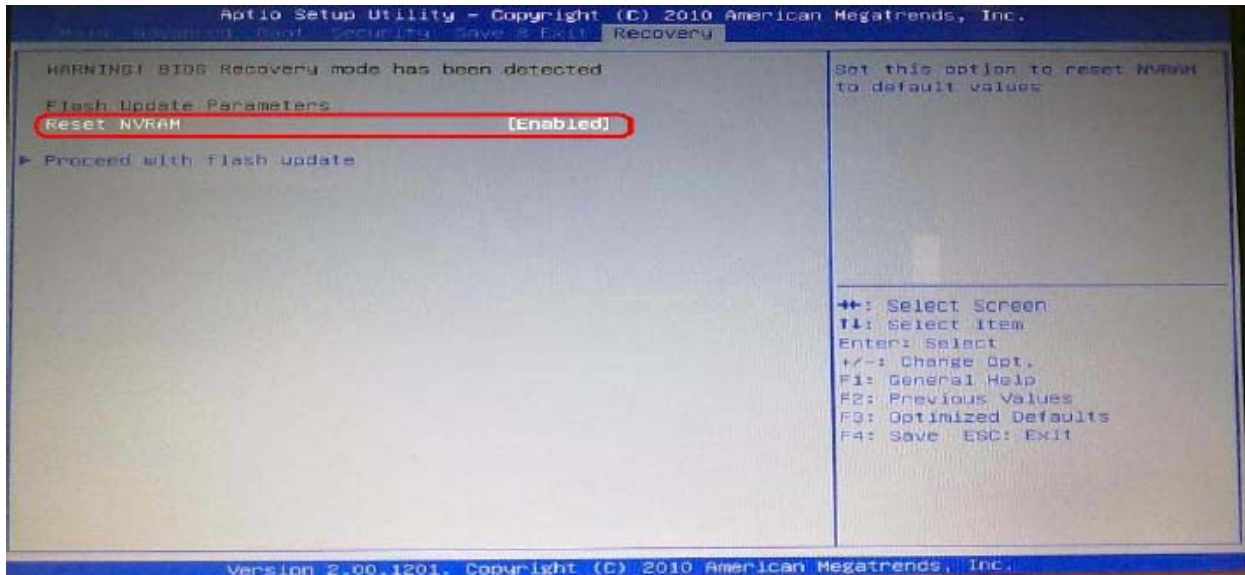

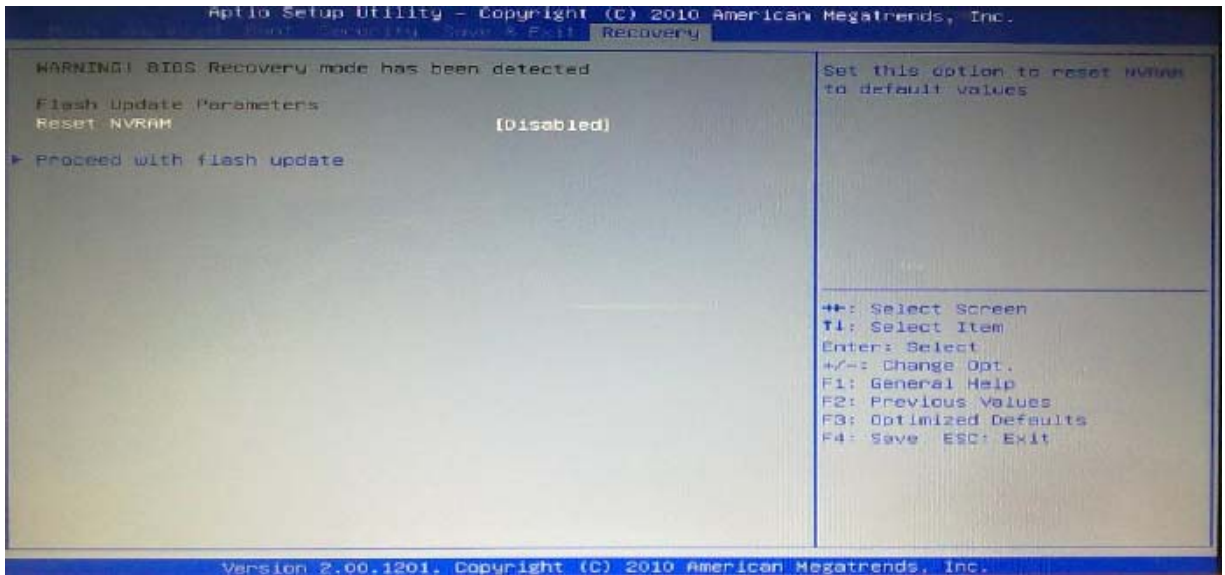

b. Select "Proceed with flash update" and Press "Enter".

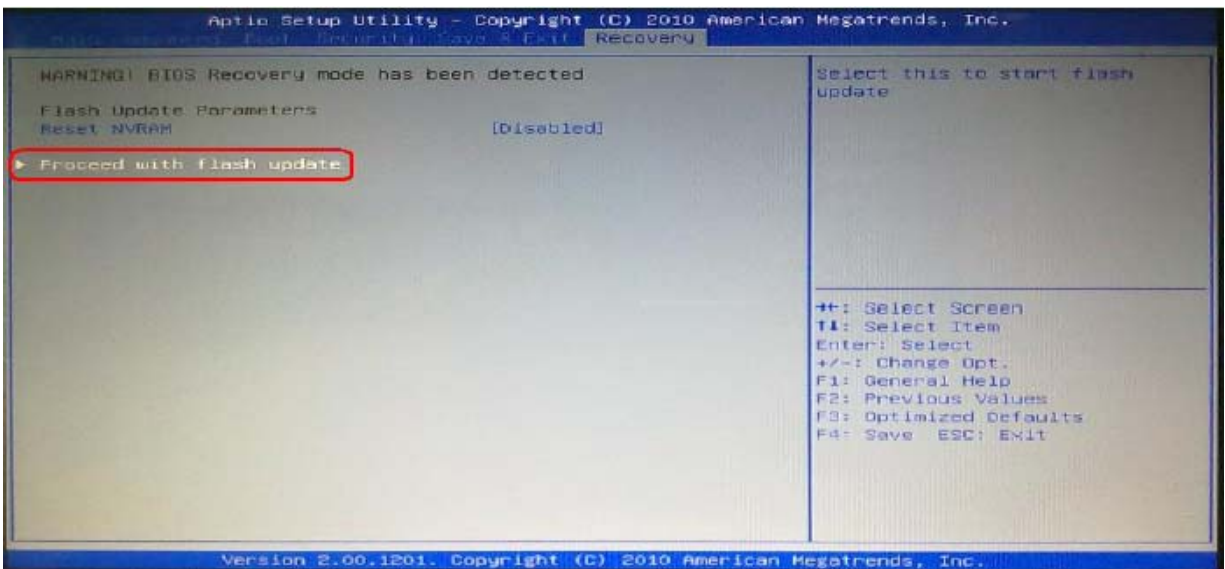

- c. System will start to flash update progress.

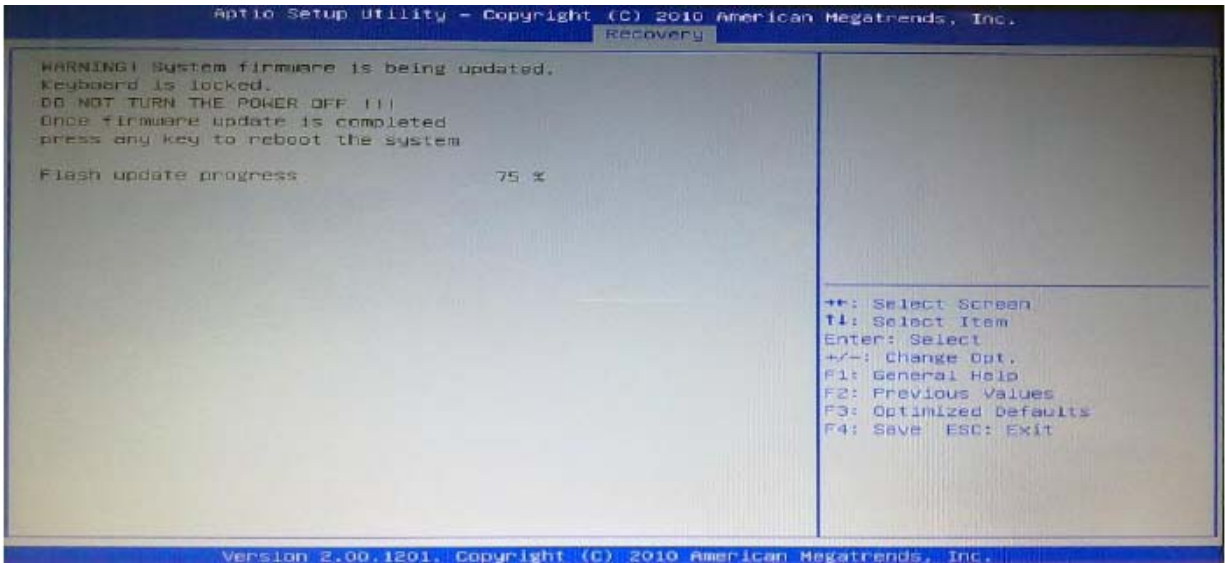

- d. Once firmware update is completed, press any key to reboot the system.

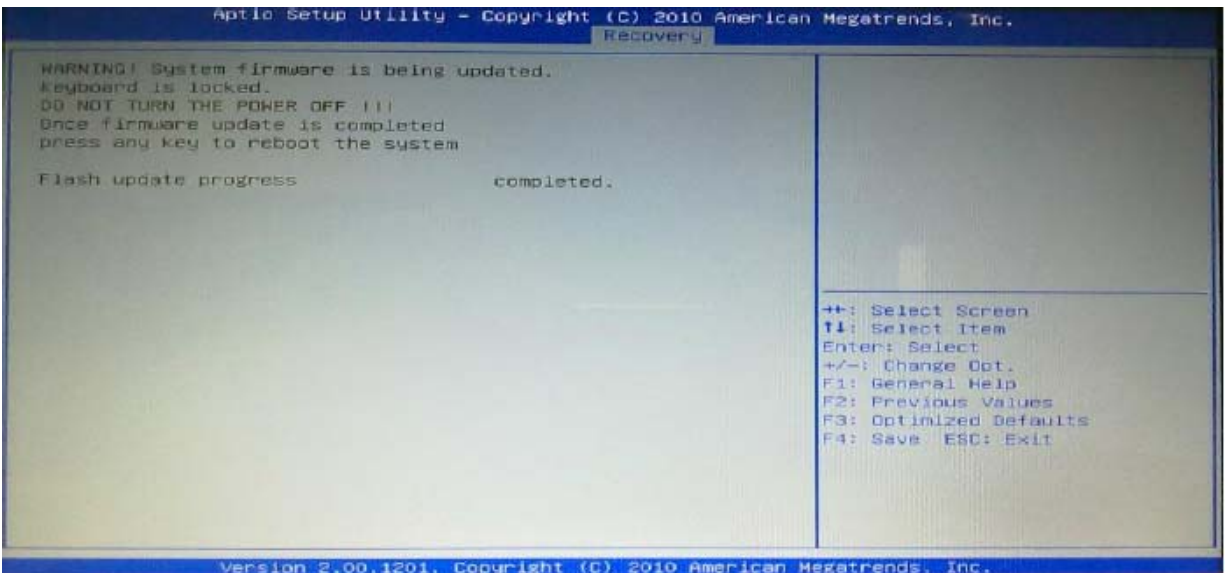

Jumper and Connector Information

M/B Placement

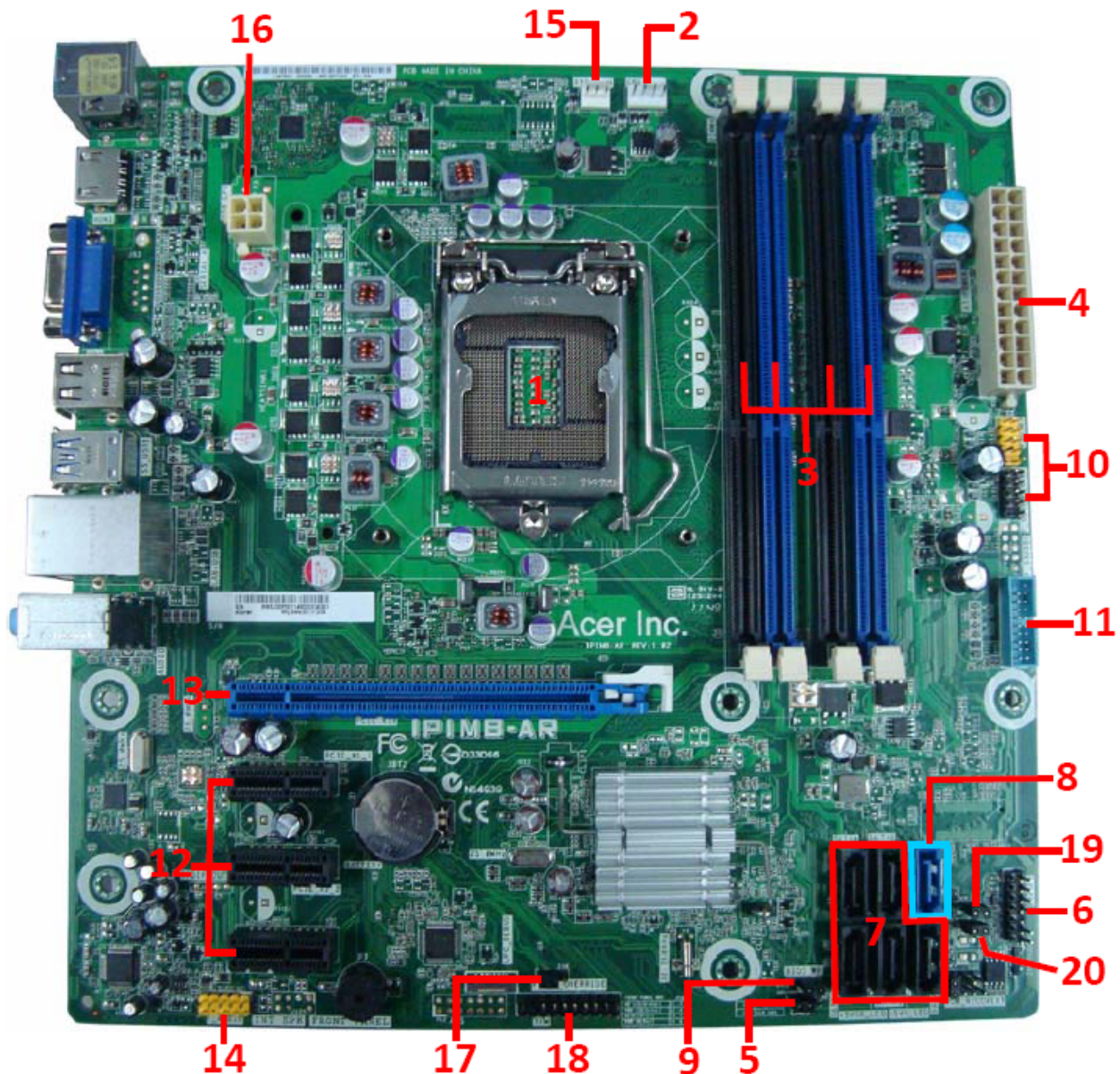

No	Label	Description	No	Label	Description
1	CPU socket	LGA1155 socket for Intel	2	CPU_FAN1	CPU cooling fan connector
3	DIMM1~4	240-pin DDR3 SDRAM slots	4	ATXPOWER	Standard 24-pin ATX power connector
5	CMOS	Clear CMOS header	6	FRONT PANEL	Front panel switch/ LED header

No	Label	Description	No	Label	Description
7	SATA1~5	Serial ATA Gen2 connectors	8	SATA0	Serial ATA Gen3 connector
9	BIOS_WP	BIOS write protect header	10	F_USB1~2	Front panel USB2 headers
11	F_SSUSB1	Front panel USB3 header	12	PCIE_X1_1~3	PCI Express x1 slot
13	PCIE_X16	PCI Express x16 slot	14	F_AUDIO	Front panel audio header
15	SYS_FAN1	System fan connector	16	ATX_CPU	Auxiliary 4-pin power connector
17	FLASH_OVERRIDE	Flash override header	18	TPM	TPM header
19	J129	Board ID header	20	J128	Board ID header

Jumper Setting

This section explains how to set the jumper for correct configuration of the main board.

Jumpers with more than one pin are numbered. When setting a jumper, ensure that the jumper caps are placed on the correct pins.

The following illustration shows the location of SW1.

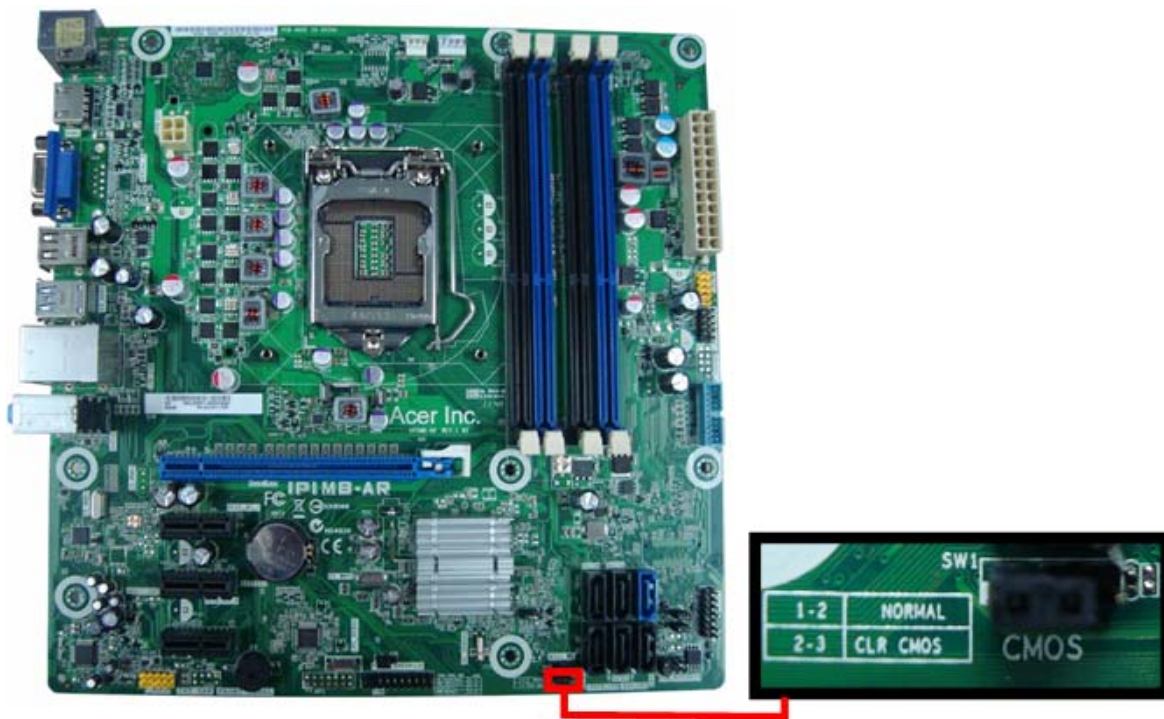

The following table shows the settings of the 3-pin SW1 jumper. Place the jumper cap on pins 1 and 2 to close or short the jumper. Place the jumper cap on pins 2 and 3 to open or clear CMOS.

Jumper	Type	Description	Setting (default)	
SW1	3-pin	Clear CMOS	1-2: Close (default) 2-3: Open Before clearing the CMOS, make sure to turn off the system.	 CLR_CMOS

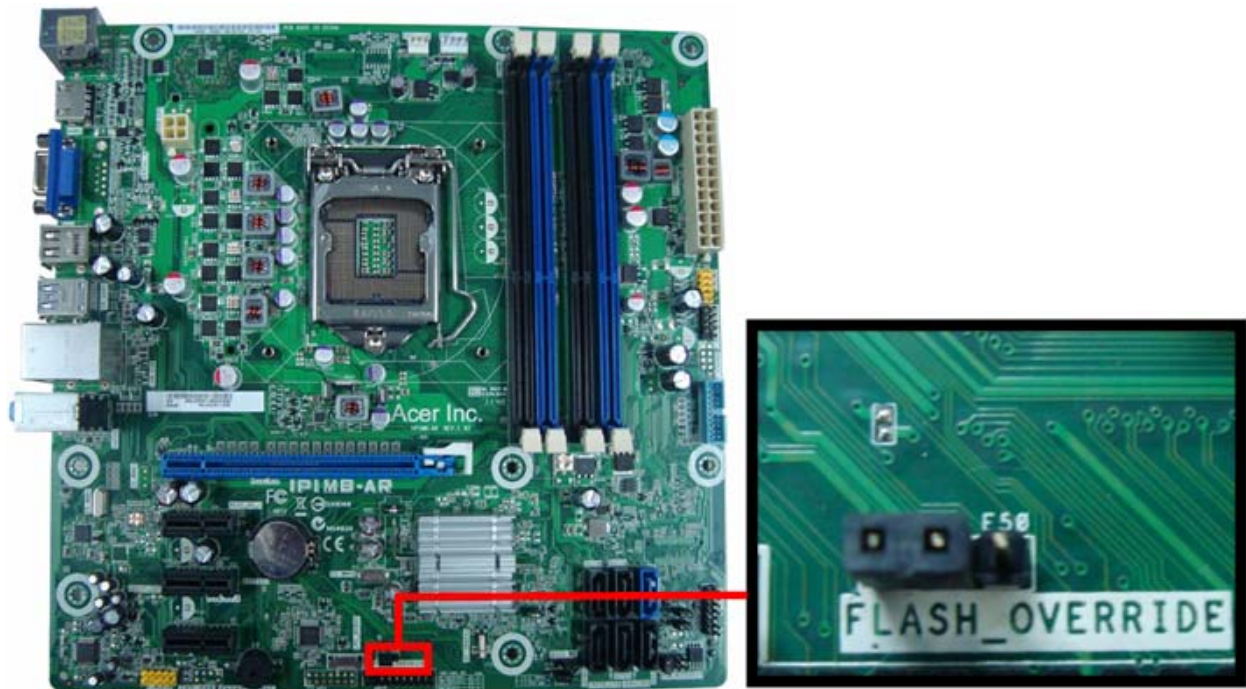

The following table shows the settings of the 3-pin E50 jumper. Place the jumper cap on pins 1 and 2 to Enable ME OVERRIDE. Place the jumper cap on pins 2 and 3 to Disable ME OVERRIDE.

Jumper	Type	Description	Setting (default)	
E50	3-pin	FLASH_OVERRIDE	1-2: Enable ME(default) 2-3: Disable ME	 1

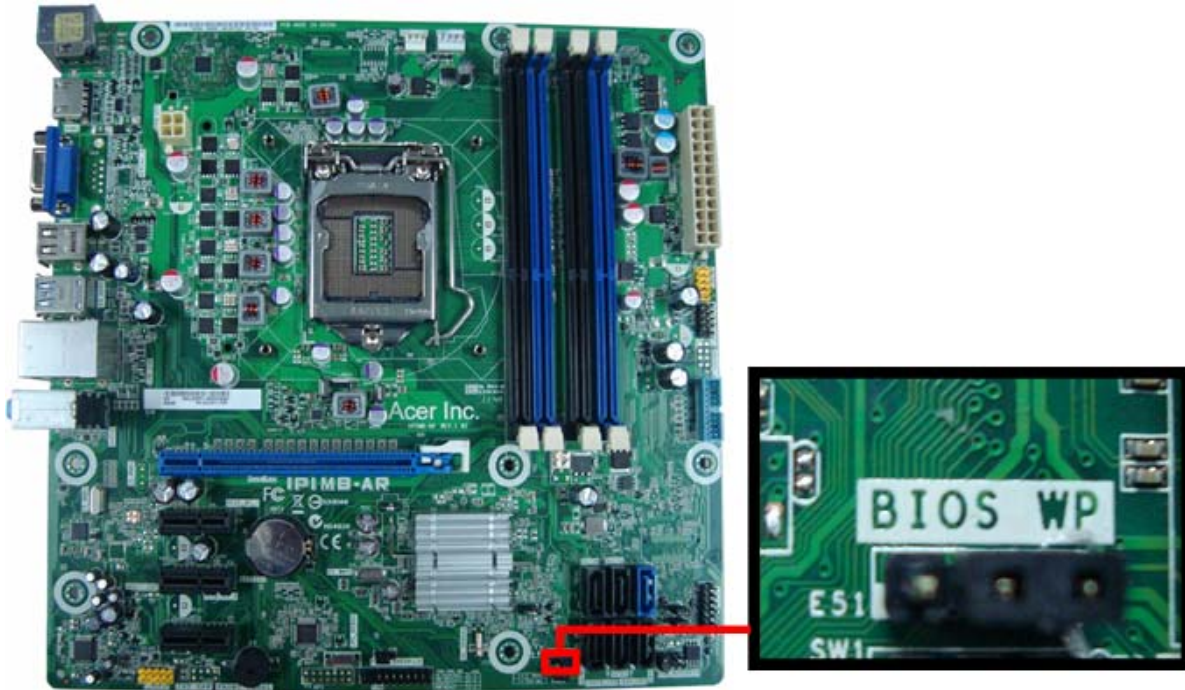

The following table shows the settings of the 3-pin E51 jumper. Place the jumper cap on pins 1 and 2 to Enable Protection. Place the jumper cap on pins 2 and 3 to Disable Protection.

Jumper	Type	Description	Setting (default)	
E51	3-pin	BIOS write Protection	1-2: Enable 2-3: Disable(default)	1 

Internal header pin definition

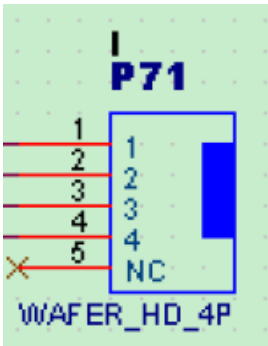
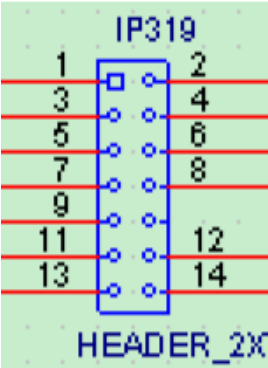
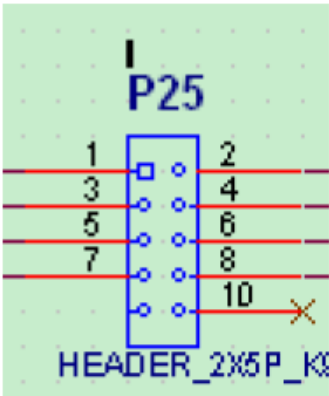
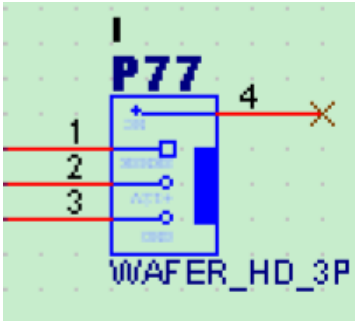

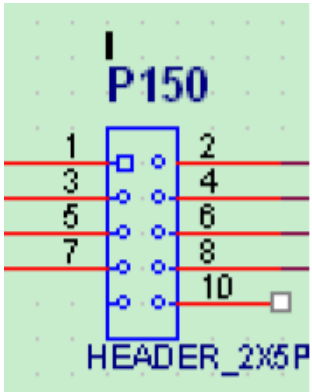
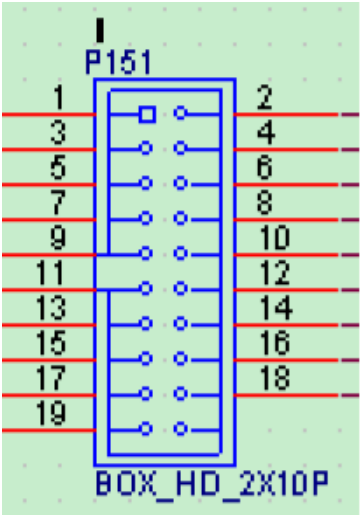
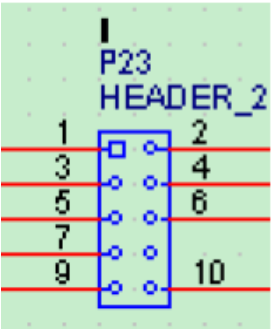
Header Name	Function	Definition
1. I/O connector		
	CPU FAN HEADER	1: GND 2: +12V 3: CPUFAN_TACH 4: CPUFAN_PWM 5: NC
	FRONT PANEL HEADER	1: HD_LED# 2: FP_LED+ 3: GND 4: GND 5: GND 6: PWRBTN# 7: SYS_RESET# 8: GND 9: NC 10: KEY 11: +5VSB 12: FP_ACTP 13: NC 14: LAN_ACT#
	FRONT USB HEADER	1: +SBV1213 2: +SBV1213 3: LP12- 4: LP13- 5: LP12+ 6: LP13+ 7: GND 8: GND 9: KEY 10: NC
	SYS FAN HEADER	1: SFAN1_TACH 2: SFAN1_PWR_3P 3: GND 4: NC

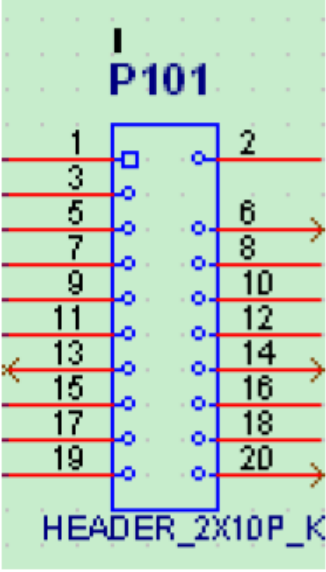
Header Name	Function	Definition
 <p>P150 HEADER_2X5P</p>	FRONT USB HEADER	1: +SBV89 2: +SBV89 3: LP9- 4: LP8- 5: LP9+ 6: LP8+ 7: GND 8: GND 9: KEY 10: NC
 <p>P151 BOX_HD_2X10P</p>	FRONT USB3.0 HEADER	1: USB3_HEADER_P1 2: LP0+ 3: LP1+ 4: LP0- 5: LP1- 6: GND 7: GND 8: USB3_TX_H_P1 9: USB3_TX_H_P2 10: USB3_TX_H_N1 11: USB3_TX_H_N2 12: GND 13: GND 14: USB3_RX_H_P1 15: USB3_RX_H_P2 16: USB3_RX_H_N1 17: USB3_RX_H_N2 18: +5V_DUAL 19: +5V_DUAL 20: KEY
 <p>P23 HEADER_2</p>	FRONT AUDIO HEADER	1: MIC2_L 2: AGND 3: MIC2_R 4: F_AUDIO_DET# 5: LIN2_R 6: MIC2_RTU 7: AGND 8: KEY 9: LIN2_L 10: LIN2_RTU

Header Name	Function	Definition
	TPM HEADER	1: CK_33M_TPM 2: GND 3: LFRAME# 4: KEY 5: PLTRST# 6: NC 7: LAD3 8: LAD2 9: +3P3V 10: LAD1 11: LAD0 12: GND 13: NC 14: NC 15: +3P3VSB 16: SERIRQ 17: GND 18: F_CLKRUN# 19: LPCPD# 20: NC

Connector pin definition

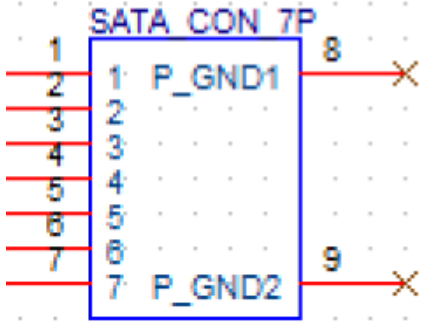
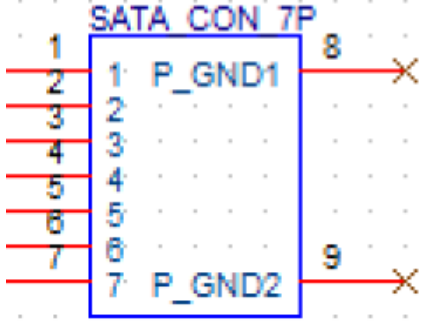
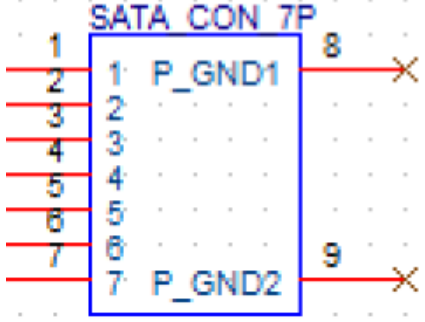
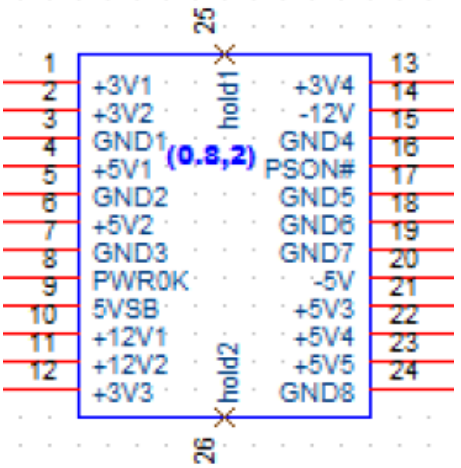
<p>J68 MINI_DIN_6PX2 PS2_MOUSE</p> <p>10 VCC2 MDATA 7 9 GND2 MCLK 11 13 SIDE_G13 NC3 8 14 SIDE_G14 NC4 12 X</p> <p>PS2_KB</p> <p>4 VCC1 KDATA 1 3 GND1 KCLK 5 15 SIDE_G15 NC1 2 X 16 SIDE_G16 NC2 6 X 17 SIDE_G17</p>	<p>PSKBMS CONN</p>	<p>1: CKBDATA 2: NC 3: GND 4: +5V_KBMS 5: CKBCLK 6: NC 7: CMSDATA 8: NC 9: GND 10: +5V_KBMS 11: CMSCLK 12: NC 13: GND 14: GND 15: GND 16: GND 17: GND</p>
<p>J69</p> <p>16</p> <p>8 SIDE_G16</p> <p>11 PDP BCP 7 SIDE_G13 BCP 2 SIDE_G13 GREEN 12 DATA 8 SIDE_G13 BLUE 3 VHSYNC 13 VHSYNC 9 VCC 4 BCP 14 VVSYNC 10 SIDE_G13 BLUE 5 SIDE_G13 BLUE 15 DCLK</p> <p>17</p> <p>17 SIDE_G17</p> <p>DDC_CONN_15P3R</p>	<p>VGA CONN</p>	<p>1: RED 2: GREEN 3: BLUE 4,11: NC 9: +5V_VGA_IN 12: VGADATA 13: VHSYNC 14: VVSYNC 15: VGACLK 5,6,7,8,10,16,17: GND</p>
<p>P80</p> <p>1 GND1 HOLD1 8 X 2 TX+ 3 TX- 4 GND2 5 RX- 6 RX+ 7 GND3 HOLD2 9 X</p> <p>SATA_CON_7P</p>	<p>SATA CONN(BLUE)</p>	<p>1: GND 2: SATA_TXP0_C 3: SATA_TXN0_C 4: GND 5: SATA_RXN0_C 6: SATA_RXP0_C 7: GND 8: NC 9: NC</p>

	SATA CONN(BLACK)	1: GND 2: SATA_TXP1_C 3: SATA_TXN1_C 4: GND 5: SATA_RXN1_C 6: SATA_RXP1_C 7: GND 8:NC 9:NC
	SATA CONN(BLACK)	1: GND 2: SATA_TXP2_C 3: SATA_TXN2_C 4: GND 5: SATA_RXN2_C 6: SATA_RXP2_C 7: GND 8:NC 9:NC
	SATA CONN(BLACK)	1: GND 2: SATA_TXP3_C 3: SATA_TXN3_C 4: GND 5: SATA_RXN3_C 6: SATA_RXP3_C 7: GND 8:NC 9:NC
	ATX_POWER CONN	1:+3P3V 14:-12V 2: +3P3V 15:GND 3: GND 16: ATX_PSO 4:+5V 17:GND 5:GND 18:GND 6:+5V 19:GND 7:GND 20:-5V 8: ATX_PWRGD_PWRCORD 9:+5VA 21:+5V 10:+12V 22:+5V 11:+12V 23:+5V 12:+3P3V 24:GND 13:+3P3V
	ATX12V CONN	1: GND 2: GND 3: +12V_CPU 4: +12V_CPU

<p>J124</p> <p>7 TMDA_DATA0+ 18 +5V_POWER 9 TMDA_DATA0- 4 TMDA_DATA1+ 6 TMDA_DATA1- 1 TMDA_DATA2+TMDA_DATA0_SHIELD 8 3 TMDA_DATA2-TMDA_DATA1_SHIELD 5 2 11 TMDA_DATA2_SHIELD 10 TMDA_TMDA_CLOCK_SHIELD 12 TMDA_CLOCK+ TMDA_CLOCK- 16 SDA 19 HPDET 15 SCL 13 CEC 20 P_GND1 17 DDC/CEC_GROUND 21 P_GND2 22 P_GND3 23 P_GND4 14 RESERVED 24 NP_NC</p> <p>HDMI CON 19P</p>	<p>HDMI_CON_19P</p>	<p>1: HDMI_TMDS_DATA2_P 2: GND 3: HDMI_TMDS_DATA2_N 4: HDMI_TMDS_DATA1_P 5: GND 6: HDMI_TMDS_DATA1_N 7: HDMI_TMDS_DATA0_P 8:GND 9: HDMI_TMDS_DATA0_N 10: HDMI_TMDS_CLK_P 11:GND 12: HDMI_TMDS_CLK_N 13~14:NC 15: HDMI_DDC_CLK_LS 16: HDMI_DDC_DATA_LS 17:GND 18: +5V_HDMI 19: HDMI_HOTPLUG_DET 20~23:GND 24:NC</p>
<p>J10</p> <p>2 1P- 1 VCC1 3 1P+ 4 GND1 6 2F- 5 VCC2 7 2F+ 8 GND2 9 SIDE_G9 11 SIDE_G11 10 SIDE_G10 12 SIDE_G12</p>	<p>USB_CON_2X4P</p>	<p>1: +5V_DUAL_USB_B 2: LP5- 3: LP5+ 4: GND 5: +5V_DUAL_USB_B 6: LP4- 7: LP4+ 8~ 12:GND</p>

	<p>USB_CON_2X9P</p>	<p>1: +5V_DUAL_USB_B 2: LP2- 3: LP2+ 4: GND 5: USB3_SS_RXN3 6: USB3_SS_RXP3 7: GND 8: USB3_SS_TXN3 9: USB3_SS_TXP3 10: +R_VBUS_OUT 11: LP3- 12: LP3+ 13: GND 14: USB3_SS_RXN4 15: USB3_SS_RXP4 16: GND 17: USB3_SS_TXN4 18: USB3_SS_TXP4 19,20: GND</p>
	<p>AUDIO_3IN1_AZA_13P</p>	<p>1: GND 2: MIC1_L 3: MIC1_JD 4: GND 5: MIC1_R 22: FRONT_L 23: FRONT_JD 24: GND 25: FRONT_R 32: LIN1_L 33: LIN1_JD- 34: GND 35: LIN1_R G1-G4: AGND</p>

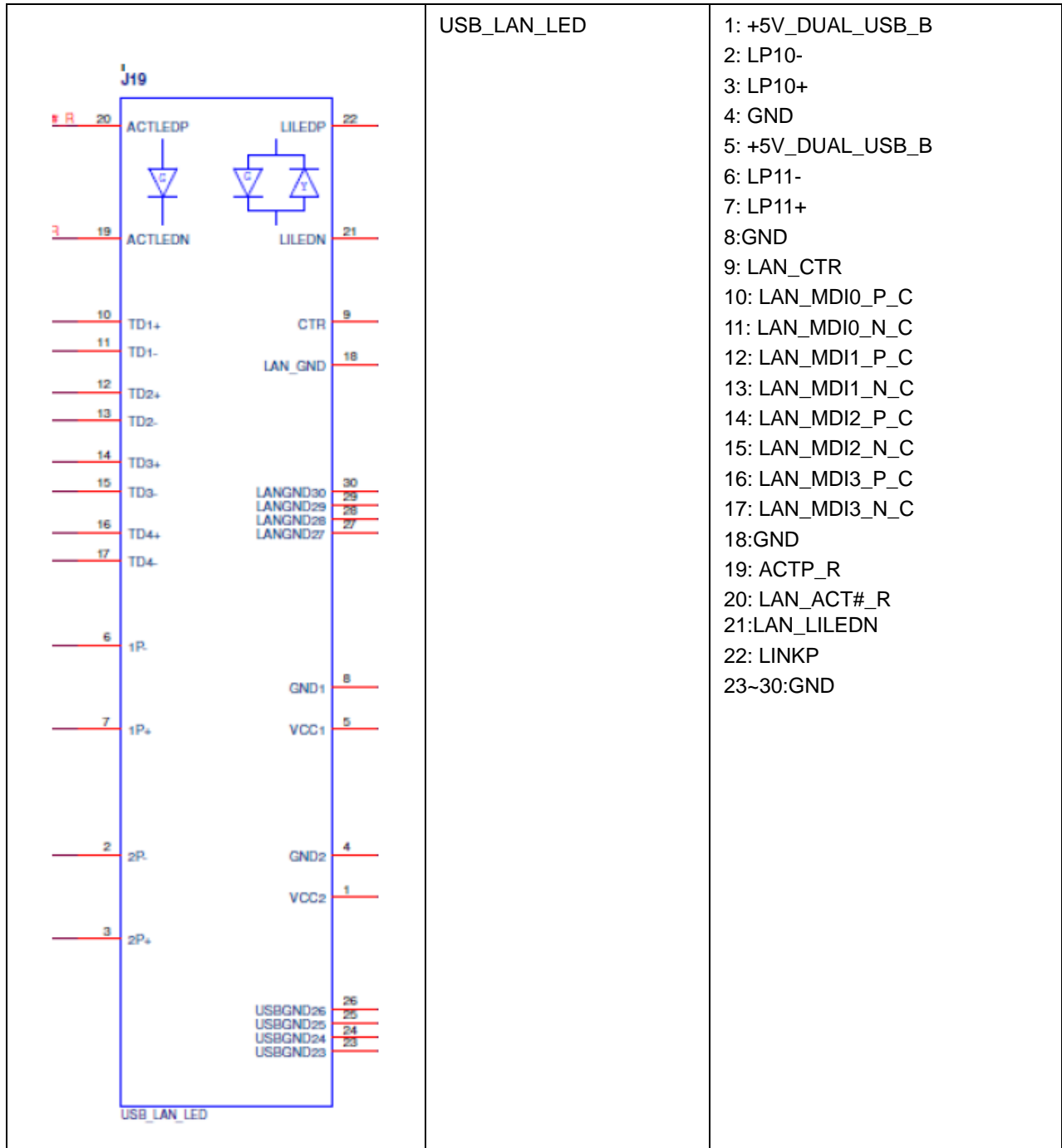

FRU (Field Replaceable Unit) List

This chapter offers the FRU (Field Replaceable Unit) list in global configuration of the Predator G3620 desktop computer. Refer to this chapter whenever ordering the parts to repair or for RMA (Return Merchandise Authorization).

NOTES:

- When ordering FRU parts, check the most up-to-date information available on your regional web or channel. For whatever reasons a part number is changed, it will NOT be noted on the printed Service Guide. For Acer authorized service providers, your Acer office may have a different part number code from those given in the FRU list of this printed Service Guide. You MUST use the local FRU list provided by your regional Acer office to order FRU parts for service.
- To scrap or to return the defective parts, follow the local government ordinance or regulations on how to dispose it properly, or follow the rules set by your regional Acer office on how to return it.
- This document will be updated as more information about the FRU list becomes available.



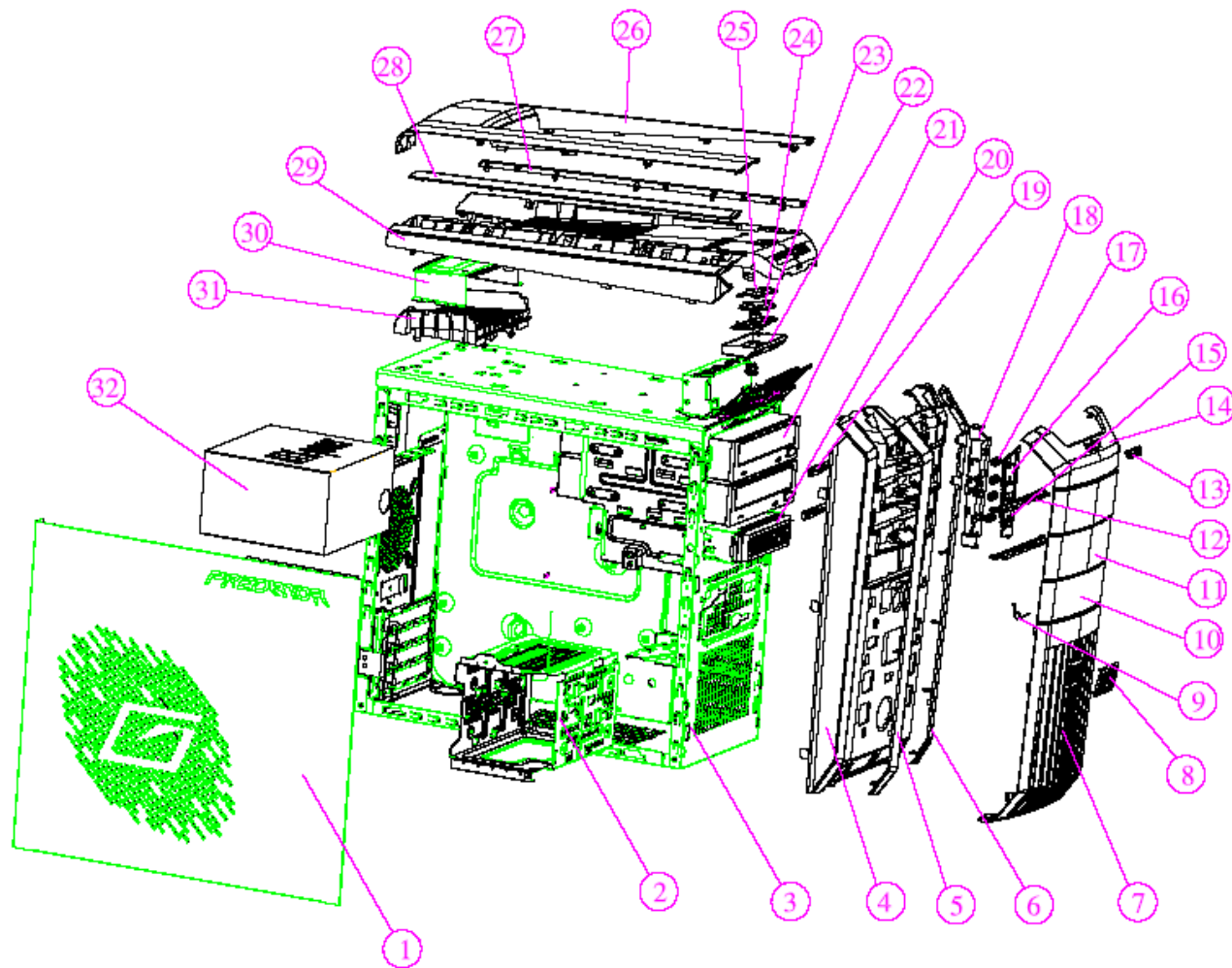

Predator G3620 Exploded Diagram



NOTE: This section will be updated when more information becomes available.





ITEM	NAME	Q'TY	ITEM	NAME	Q'TY
1	SIDE COVER	1	17	ODD-BUTTON-SPRING	4
2	HDD COVER	1	18	ODD-BUTTON-HOLDER	1
3	CHASSIS	1	19	BUTTON-ODD-F-MATCH-A	2
4	MAIN BEZEL	1	20	HDD-CARRIER-CAGE	1
5	FRONT-BEZEL-COSMETIC-A	1	21	ODD	2
6	FRONT-BEZEL-COSMETIC-B	1	22	POWER-BUTTON-HOLDER	1
7	FRONT-BEZEL-COVER	1	23	POWER-BRACKET	1
8	G-LOGO	1	24	POWER-02	1
9	SPRING-HDD-DOOR	2	25	POWER-01	1
10	HDD-DOOR	1	26	TOP-BEZEL-COVER	1
11	ODD-DOOR	2	27	TOP-BEZEL-COSMETIC-A	1
12	ODD-DOOR-ARM	2	28	TOP-BEZEL-COSMETIC-B	1
13	ACER-LOGO	1	29	TOP-BEZEL	1
14	FRONT -BEZEL-TOP-COVER	1	30	CHASSIS-HANDER	1
15	ODD-BUTTON-DOWN	1	31	CHASSIS-HAND-COVER	1
16	ODD-BUTTON-UP	1	32	ATX-POWER	1





Predator G3620 FRU List

Category	Part Number	Acer P/N	Exploded Diagram Item
MB Kit			
	MB Kit aGoran_M3 Intel B75 uATX W/O 1394 LF	MB.SJQ0P.001	N/A
Chassis			
	Hon Hai Chassis MicroATX HM105A with front USB port (vertical) for Predator G3 Bezel BM350 w/o 3.5" HDD carrier (2011 New CI)	HS.13100.241	N/A
	Hon Hai Chassis MicroATX HM105B with front USB port (vertical) for Predator G3 Bezel BM351 w/i one 3.5" HDD carrier (2011 New CI)	HS.13100.242	
Bezel			
	Wistron(LY) Predator Bezel BM350 USB 4 port (vertical) bezel for HM105A, w/o 3.5" HDD carrier	PZ.11900.226	N/A
	Wistron(LY) Predator Bezel BM351 USB 4 port (vertical) bezel for HM105B, w/i one 3.5" HDD carrier	PZ.11900.227	
CPU			
	"CPU Intel Core i7 2600 3.4G 8M 1333 95W D-2 LGA-1155, Sandy Bridge"	KC.26001.CI7	N/A
	"Core i3-2120 (3.30G 3M DDR3 1333) , Q0 , 65W , Intel HD Graphics 2000"	KC.21201.CI3	
	"Pentium G850 (2.9G/3MB/DDR3 1333) , Q0 , 65W , Intel HD Graphics "	KC.85001.DEG	
	Pentium Dual Core G630 (2.7G 3M 1066FSB)	KC.63001.DEG	
	Celeron G530 (2.4G 2M 1066FSB LGA1155)	KC.53001.CDG	
	Celeron G460 (1.7G 1.5M 1066FSB LGA1155)	KC.G0001.460	
	Ivy Bridge E-0 6MB 4c LGA 3.1GHz STD 77W I5-3450 (FLOOR) GT1 QS	KC.34501.CI5	
	Ivy Bridge E-0 6MB 4c LGA 3.3GHz STD 77W I5-3550 (HIGH BIN) VPRO GT1 QS	KC.35501.CI5	

Category	Part Number	Acer P/N	Exploded Diagram Item
	Ivy Bridge E-0 4c LGA 95W i7-3770 VPRO QS	KC.37701.CI7	
	Core i5-2400 (3.1G 6M 1333FSB)	KC.24001.CI5	
	"Core i3-2120 (3.30G 3M DDR3 1333) , Q0 , 65W , Intel HD Graphics 2000"	KC.21201.CI3	
	Ivy Bridge E-0 4c LGA 95W i7-3770 VPRO QS	KC.37701.CI7	
Memory			
	GU502203EP0201 LF 128*8 0.065um	KN.1GB0H.015	N/A
	ACR128X64D3U1333C9 LF 128*8 0.07um	KN.1GB07.002	
	NT1GC64BH4B0PF-CG	KN.1GB03.035	
	HU524303EP0200	KN.2GB0H.012	
	NT2GC64B88B0NF-CG 256*8 50nm	KN.2GB03.022	
	ACR256X64D3U13C9G	KN.2GB07.007	
	NT4GC64B8HB0NF-CG	KN.4GB03.006	
	MT16JTF51264AZ-1G4D1	KN.4GB04.002	
	HU564403EP0200	KN.4GB0H.001	
	ACR512X64D3U13C9G	KN.4GB07.002	
HDD			
	"HDD SEAGATE 3.5"" 7200rpm 320GB ST3320413AS(Pharaoh 6G) SATA III 16MB LF F/ W:JC45"	KH.32001.022	N/A
	"HDD SEAGATE 3.5"" 7200rpm 500GB ST3500413AS(Pharaoh 6G) SATA III 16MB LF F/ W:JC45"	KH.50001.022	
	"HDD SEAGATE 3.5"" 7200rpm 1000GB ST31000524AS (Pharaoh 6G) SATA III 32MB LF F/W:JC45 "	KH.01K01.016	
	"HDD SEAGATE 3.5"" 7200rpm 1500GB ST31500341AS(Brinks) SATA II 32MB LF F/ W:CC4H"	KH.15K01.002	
	"HDD WD 3.5"" 7200rpm 320GB WD3200AAKX-221CA1 XL500-1D SATA III 16MB LF F/ W:17.01H17"	KH.32008.025	
	"HDD WD 3.5"" 7200rpm 500GB WD5000AAKX-221CA1 XL500-1D SATA III 16MB LF F/ W:17.01H17"	KH.50008.025	
	"HDD WD 3.5"" 7200rpm 1000GB WD10EALX-229BA1 XL500-2 SATA III 32MB LF F/ W:17.01H17"	KH.01K08.014	
	"HDD WD 3.5"" 5400rpm 1000GB WD10EADX-22TDHB0 GP500 SATA III 32MB LF F/ W:77.04D77"	KH.01K08.013	
	"HDD WD 3.5"" 5400rpm 1500GB WD15EARS-22MVWB0 (GP667-3D) SATA II 64MB LF F/ W:51.0AB51"	KH.15K08.003	

Category	Part Number	Acer P/N	Exploded Diagram Item
	"HDD WD 3.5"" 5400rpm 1500GB WD15EARX-22PASB0 (GP667-3D) SATA III 64MB LF F/W:51.0AB51"	KH.15K08.004	
	"HDD WD 3.5"" 5400rpm 2000GB WD20EARS-22MVWB0(GP667-3D) SATA II LF F/W:51.0AB51"	KH.02K08.006	
	"HDD WD 3.5"" 5400rpm 2000GB WD20EARX-22PASB0(GP667-3D) SATA III LF F/W:51.0AB51"	KH.02K08.007	
	"HDD HGST 3.5"" 7200rpm 500GB HDS721050CLA662(Jupiter) SATA III 16MB LF F/W:JPT50E"	KH.50007.014	
	"HDD HGST 3.5"" 7200rpm 2000GB HDS723020BLA642 (Mariner) SATA III 64MB LF F/W:MNR580 "	KH.02K07.002	
	"HDD SEAGATE 3.5"" 7200rpm 1000GB ST31000524AS (Pharaoh 6G) SATA III 32MB LF F/W:JC45 "	KH.01K01.016	
	"HDD WD 3.5"" 5400rpm 1000GB WD10EARX-22N0YB0 GP667 SATA III 64MB LF F/W:51.0AB51"	KH.01K08.020	
	"HDD WD 3.5"" 5400rpm 1500GB WD15EARS-22MVWB0 (GP667-3D) SATA II 64MB LF F/W:51.0AB51"	KH.15K08.003	
	"HDD WD 3.5"" 5400rpm 2000GB WD20EARX-22PASB0(GP667-3D) SATA III LF F/W:51.0AB51"	KH.02K08.007	
	"HDD HGST 3.5"" 7200rpm 2000GB HDS723020BLA642 (Mariner) SATA III 64MB LF F/W:MNR580 "	KH.02K07.002	
	Flash Disk LITE-ON SSD NAND 64GB LCT-64M3S LF+HF	KF.0640L.002	
ODD			
	ODD HLDS DVD-ROM HH 16X DH40N LF+HF Black Bezel AC01 SATA (Win7)	KV.0160D.020	21
	ODD PLDS DVD-ROM HH 16X DH-16D6SH LF+HF Black Bezel SATA (Win7)	KV.0160F.006	
	ODD PIONEER DVD-ROM HH 16X DVR-231RS LF+HF Black Bezel SATA (Win7)	KV.01605.007	
	ODD HLDS Super-Multi DRIVE HH 16X GH70N LF+HF Black Bezel SATA (Win7)	KU.0160D.055	
	ODD PLDS Super-Multi DRIVE HH DL 16X DH-16ABSH LF Black Bezel (HF+Win7) SATA	KU.0160F.011	
	ODD PIONEER Super-Multi DRIVE HH DL 16X DVR-219RS LF Black Bezel SATA (Win7+HF)	KU.01605.007	
	ODD PLDS BD ROM HH DL 4X DH-4O3S LF Standard Bezel SATA	KV.0040F.004	
	ODD HLDS BD COMBO HH 12X CH29N Black Bezel SATA HF + Win7	KO.0120D.001	

Category	Part Number	Acer P/N	Exploded Diagram Item
	ODD PLDS BD COMBO HH DL 12X DH-12E3SH LF+HF Black Bezel SATA (HF+Win7)	KO.0120F.001	
	ODD HLDS BD RW HH 8X BH38N Black Bezel SATA HF +Win7	KU.0080D.061	
	ODD PLDS BD RW HH DL 8X DH-8B2SH LF+HF Black Bezel SATA (Win7+HF)	KU.0080F.018	
	ODD HLDS Super-Multi DRIVE HH 16X GH70N LF+HF Black Bezel SATA (Win7)	KU.0160D.055	
	ODD PLDS Super-Multi DRIVE HH DL 16X DH-16ABSH LF Black Bezel (HF+Win7) SATA	KU.0160F.011	
	ODD PIONEER Super-Multi DRIVE HH DL 16X DVR-219RS LF Black Bezel SATA (Win7+HF)	KU.01605.007	
	ODD HLDS BD COMBO HH 12X CH29N Black Bezel SATA HF + Win7	KO.0120D.001	
	ODD PLDS BD COMBO HH DL 12X DH-12E3SH LF+HF Black Bezel SATA (HF+Win7)	KO.0120F.001	
VGA			
	288-5N194-000AC GTX550Ti 1GB 192bit GDDR5 DVI + DVI + HDMI + DP SAMSUNG ATX	VG.PCPT5.501	N/A
	288-6N178-000AC GT545 3GB 192bit DDR3 DVI + HDMI + DP SAMSUNG ATX	VG.PCP54.5A1	
	288-6N178-100AC GT545 3GB 192bit DDR3 DVI + HDMI + DP HYNIX ATX	VG.PCP54.5A2	
	288-1N222-001AC 510 1GB DDR3 64bits DVII + HDMI + VGA Hynix ATX	VG.PCPT5.101	
	288-1E181-101AC HD6570 1GB DDR3 128bits DVI-I (DL) + HDMI SAMSUNG ATX	VG.APC65.711	
	288-2E180-000AC HD6450 1GB SDDR3 64bits DVI-I + HDMI SAMSUNG (ATX)	VG.APC64.522	
	GTX660 2GB GDDR5 DVI DVI HDMI DP ATX	VG.PCP66.001	
	AMD HD7870 2GB GDDR5 DVI HDMI miniDP miniDP ATX BRACKET ROHS	VG.A7870.001	
	GTX645 1GB GDDR5 DVI DVI HDMI DP ATX	VG.PCP64.501	
	GT635 3GB 192bit DDR3 DVI HDMI DP ATX	VG.PCP63.501	
	GT630 2GB 128bit DDR3 DVI HDMI VGA ATX	VG.PCP63.001	
Power Supply			
	FSP500-70EP 500W Active PFC 100-127V/220-240V, full 500W	PY.50008.007	32
	PS-6451-5AE	PY.5000B.003	

Category	Part Number	Acer P/N	Exploded Diagram Item
Modem			
	D-1156E#/A10A, Modem PCI-Ex1 card, LSI Universal Modem (PCI-E) 56K V.92 - Concorde (C40)	FX.10100.002	N/A
WLAN			
	WN7601R, Ralink RT3090, 802.11b/g/n 1x1 WLAN PCI-E x1 card	NI.10200.037	N/A
External Speaker			
	JS speaker USB MS1238UA with new acer logo	SP.10600.048	N/A
	JS speaker USB MS1238UA with new acer logo (meet AJC spec)	SP.10600.049	
	Neosonica speaker USB 9M-20A200-000 with new acer logo (meet AJC Spec.)	SP.10600.052	
Mouse			
	Logitech Optical mouse PS2 M-S0004-O with acer logo	MS.11200.104	N/A
	Primax Optical mouse PS2 MOFGKO with acer logo	MS.11200.105	
	Primax mouse RF2.4 MORFF9UO black color;with new acer logo	MS.11200.113	
	Primax mouse RF2.4 MORFF9UO black color;with new acer logo;without battery	MS.11200.114	
	Primax mouse USB MOF9UO black color;with new acer logo	MS.11200.115	
	Lite-on mouse RF2.4 SM-9063B black;with new acer logo	MS.11200.121	

Category	Part Number	Acer P/N	Exploded Diagram Item
	Lite-on mouse RF2.4 SM-9063B black;with new acer logo;without battery	MS.11200.122	
	Lite-on mouse USB SM-9020B black;with new acer logo	MS.11200.123	
Keyboard			
	Keyboard LITE-ON SK-9660B RF2.4 Black US with new acer logo	KB.RF40B.167	N/A
	Keyboard LITE-ON SK-9660B RF2.4 Black Traditional Chinese with new acer logo	KB.RF40B.168	
	Keyboard LITE-ON SK-9660B RF2.4 Black Simplified Chinese with new acer logo	KB.RF40B.169	
	Keyboard LITE-ON SK-9660B RF2.4 Black US International with new acer logo	KB.RF40B.170	
	Keyboard LITE-ON SK-9660B RF2.4 Black Arabic/English with new acer logo	KB.RF40B.171	
	Keyboard LITE-ON SK-9660B RF2.4 Black Thailand with new acer logo	KB.RF40B.172	
	Keyboard LITE-ON SK-9660B RF2.4 Black Spanish with new acer logo	KB.RF40B.173	
	Keyboard LITE-ON SK-9660B RF2.4 Black Portuguese with new acer logo	KB.RF40B.174	
	Keyboard LITE-ON SK-9660B RF2.4 Black Canadian French with new acer logo	KB.RF40B.175	
	Keyboard LITE-ON SK-9660B RF2.4 Black Brazilian Portuguese with new acer logo	KB.RF40B.176	
	Keyboard LITE-ON SK-9660B RF2.4 Black Japanese with new acer logo	KB.RF40B.177	
	Keyboard LITE-ON SK-9660B RF2.4 Black German with new acer logo	KB.RF40B.178	
	Keyboard LITE-ON SK-9660B RF2.4 Black Italian with new acer logo	KB.RF40B.179	
	Keyboard LITE-ON SK-9660B RF2.4 Black French with new acer logo	KB.RF40B.180	
	Keyboard LITE-ON SK-9660B RF2.4 Black Swedish with new acer logo	KB.RF40B.181	
	Keyboard LITE-ON SK-9660B RF2.4 Black UK with new acer logo	KB.RF40B.182	
	Keyboard LITE-ON SK-9660B RF2.4 Black Dutch with new acer logo	KB.RF40B.183	
	Keyboard LITE-ON SK-9660B RF2.4 Black Swiss/G with new acer logo	KB.RF40B.184	
Keyboard LITE-ON SK-9660B RF2.4 Black Belgium with new acer logo	KB.RF40B.185		
Keyboard LITE-ON SK-9660B RF2.4 Black Icelandic with new acer logo	KB.RF40B.186		

Category	Part Number	Acer P/N	Exploded Diagram Item
	Keyboard LITE-ON SK-9660B RF2.4 Black Norwegian with new acer logo	KB.RF40B.187	
	Keyboard LITE-ON SK-9660B RF2.4 Black Hebrew with new acer logo	KB.RF40B.188	
	Keyboard LITE-ON SK-9660B RF2.4 Black Polish with new acer logo	KB.RF40B.189	
	Keyboard LITE-ON SK-9660B RF2.4 Black Slovenian with new acer logo	KB.RF40B.190	
	Keyboard LITE-ON SK-9660B RF2.4 Black Slovak with new acer logo	KB.RF40B.191	
	Keyboard LITE-ON SK-9660B RF2.4 Black Russian with new acer logo	KB.RF40B.192	
	Keyboard LITE-ON SK-9660B RF2.4 Black Hungarian with new acer logo	KB.RF40B.193	
	Keyboard LITE-ON SK-9660B RF2.4 Black Greek with new acer logo	KB.RF40B.194	
	Keyboard LITE-ON SK-9660B RF2.4 Black Danish with new acer logo	KB.RF40B.195	
	Keyboard LITE-ON SK-9660B RF2.4 Black Czech with new acer logo	KB.RF40B.196	
	Keyboard LITE-ON SK-9660B RF2.4 Black Romanian with new acer logo	KB.RF40B.197	
	Keyboard LITE-ON SK-9660B RF2.4 Black Turkish with new acer logo	KB.RF40B.198	
	Keyboard LITE-ON SK-9660B RF2.4 Black Turkish-Q with new acer logo	KB.RF40B.199	
	Keyboard LITE-ON SK-9660B RF2.4 Black Arabic/French with new acer logo	KB.RF40B.200	
	Keyboard LITE-ON SK-9660B RF2.4 Black Kazakh with new acer logo	KB.RF40B.201	
	Keyboard LITE-ON SK-9660B RF2.4 Black Turkmen with new acer logo	KB.RF40B.202	
	Keyboard LITE-ON SK-9660B RF2.4 Black Nordic with new acer logo	KB.RF40B.203	
	Keyboard LITE-ON SK-9660B RF2.4 Black English/Canadian French with new acer logo	KB.RF40B.204	
	Keyboard LITE-ON SK-9660B RF2.4 Black Czech/Slovak with new acer logo	KB.RF40B.205	
	Keyboard LITE-ON SK-9660B RF2.4 Black Swiss/FR with new acer logo	KB.RF40B.206	
	Keyboard LITE-ON SK-9660B RF2.4 Black Korean with new acer logo	KB.RF40B.207	
	Keyboard LITE-ON SK-9660B RF2.4 Black Spanish Latin with new acer logo	KB.RF40B.208	

Category	Part Number	Acer P/N	Exploded Diagram Item
	Keyboard LITE-ON SK-9660B RF2.4 Black Spanish Latin without battery;with new acer logo	KB.RF40B.209	
	Keyboard LITE-ON SK-9621B USB Black US with new acer logo	KB.USB0B.448	
	Keyboard LITE-ON SK-9621B USB Black Traditional Chinese with new acer logo	KB.USB0B.449	
	Keyboard LITE-ON SK-9621B USB Black Simplified Chinese with new acer logo	KB.USB0B.450	
	Keyboard LITE-ON SK-9621B USB Black US International with new acer logo	KB.USB0B.451	
	Keyboard LITE-ON SK-9621B USB Black Arabic/English with new acer logo	KB.USB0B.452	
	Keyboard LITE-ON SK-9621B USB Black Thailand with new acer logo	KB.USB0B.453	
	Keyboard LITE-ON SK-9621B USB Black Spanish with new acer logo	KB.USB0B.454	
	Keyboard LITE-ON SK-9621B USB Black Portuguese with new acer logo	KB.USB0B.455	
	Keyboard LITE-ON SK-9621B USB Black Canadian French with new acer logo	KB.USB0B.456	
	Keyboard LITE-ON SK-9621B USB Black Brazilian Portuguese with new acer logo	KB.USB0B.457	
	Keyboard LITE-ON SK-9621B USB Black Japanese with new acer logo	KB.USB0B.458	
	Keyboard LITE-ON SK-9621B USB Black German with new acer logo	KB.USB0B.459	
	Keyboard LITE-ON SK-9621B USB Black Italian with new acer logo	KB.USB0B.460	
	Keyboard LITE-ON SK-9621B USB Black French with new acer logo	KB.USB0B.461	
	Keyboard LITE-ON SK-9621B USB Black Swedish with new acer logo	KB.USB0B.462	
	Keyboard LITE-ON SK-9621B USB Black UK with new acer logo	KB.USB0B.463	
	Keyboard LITE-ON SK-9621B USB Black Dutch with new acer logo	KB.USB0B.464	
	Keyboard LITE-ON SK-9621B USB Black Swiss/G with new acer logo	KB.USB0B.465	
	Keyboard LITE-ON SK-9621B USB Black Belgium with new acer logo	KB.USB0B.466	
	Keyboard LITE-ON SK-9621B USB Black Icelandic with new acer logo	KB.USB0B.467	
	Keyboard LITE-ON SK-9621B USB Black Norwegian with new acer logo	KB.USB0B.468	

Category	Part Number	Acer P/N	Exploded Diagram Item
	Keyboard LITE-ON SK-9621B USB Black Hebrew with new acer logo	KB.USB0B.469	
	Keyboard LITE-ON SK-9621B USB Black Polish with new acer logo	KB.USB0B.470	
	Keyboard LITE-ON SK-9621B USB Black Slovenian with new acer logo	KB.USB0B.471	
	Keyboard LITE-ON SK-9621B USB Black Slovak with new acer logo	KB.USB0B.472	
	Keyboard LITE-ON SK-9621B USB Black Russian with new acer logo	KB.USB0B.473	
	Keyboard LITE-ON SK-9621B USB Black Hungarian with new acer logo	KB.USB0B.474	
	Keyboard LITE-ON SK-9621B USB Black Greek with new acer logo	KB.USB0B.475	
	Keyboard LITE-ON SK-9621B USB Black Danish with new acer logo	KB.USB0B.476	
	Keyboard LITE-ON SK-9621B USB Black Czech with new acer logo	KB.USB0B.477	
	Keyboard LITE-ON SK-9621B USB Black Romanian with new acer logo	KB.USB0B.478	
	Keyboard LITE-ON SK-9621B USB Black Turkish with new acer logo	KB.USB0B.479	
	Keyboard LITE-ON SK-9621B USB Black Turkish-Q with new acer logo	KB.USB0B.480	
	Keyboard LITE-ON SK-9621B USB Black Arabic/French with new acer logo	KB.USB0B.481	
	Keyboard LITE-ON SK-9621B USB Black Kazakh with new acer logo	KB.USB0B.482	
	Keyboard LITE-ON SK-9621B USB Black Turkmen with new acer logo	KB.USB0B.483	
	Keyboard LITE-ON SK-9621B USB Black Nordic with new acer logo	KB.USB0B.484	
	Keyboard LITE-ON SK-9621B USB Black English/Canadian French with new acer logo	KB.USB0B.485	
	Keyboard LITE-ON SK-9621B USB Black Czech/Slovak with new acer logo	KB.USB0B.486	
	Keyboard LITE-ON SK-9621B USB Black Swiss/FR with new acer logo	KB.USB0B.487	
	Keyboard LITE-ON SK-9621B USB Black Korean with new acer logo	KB.USB0B.488	
	Keyboard LITE-ON SK-9621B USB Black Spanish Latin with new acer logo	KB.USB0B.489	
	Keyboard LITE-ON SK-9611 PS/2 Black US with new acer logo	KB.PS20B.157	

Category	Part Number	Acer P/N	Exploded Diagram Item
	Keyboard LITE-ON SK-9611 PS/2 Black Traditional Chinese with new acer logo	KB.PS20B.158	
	Keyboard LITE-ON SK-9611 PS/2 Black Simplified Chinese with new acer logo	KB.PS20B.159	
	Keyboard LITE-ON SK-9611 PS/2 Black US International with new acer logo	KB.PS20B.160	
	Keyboard LITE-ON SK-9611 PS/2 Black Arabic/English with new acer logo	KB.PS20B.161	
	Keyboard LITE-ON SK-9611 PS/2 Black Thailand with new acer logo	KB.PS20B.162	
	Keyboard LITE-ON SK-9611 PS/2 Black Spanish with new acer logo	KB.PS20B.163	
	Keyboard LITE-ON SK-9611 PS/2 Black Portuguese with new acer logo	KB.PS20B.164	
	Keyboard LITE-ON SK-9611 PS/2 Black Canadian French with new acer logo	KB.PS20B.165	
	Keyboard LITE-ON SK-9611 PS/2 Black Brazilian Portuguese with new acer logo	KB.PS20B.166	
	Keyboard LITE-ON SK-9611 PS/2 Black Japanese with new acer logo	KB.PS20B.167	
	Keyboard LITE-ON SK-9611 PS/2 Black German with new acer logo	KB.PS20B.168	
	Keyboard LITE-ON SK-9611 PS/2 Black Italian with new acer logo	KB.PS20B.169	
	Keyboard LITE-ON SK-9611 PS/2 Black French with new acer logo	KB.PS20B.170	
	Keyboard LITE-ON SK-9611 PS/2 Black Swedish with new acer logo	KB.PS20B.171	
	Keyboard LITE-ON SK-9611 PS/2 Black UK with new acer logo	KB.PS20B.172	
	Keyboard LITE-ON SK-9611 PS/2 Black Dutch with new acer logo	KB.PS20B.173	
	Keyboard LITE-ON SK-9611 PS/2 Black Swiss/G with new acer logo	KB.PS20B.174	
	Keyboard LITE-ON SK-9611 PS/2 Black Belgium with new acer logo	KB.PS20B.175	
	Keyboard LITE-ON SK-9611 PS/2 Black Icelandic with new acer logo	KB.PS20B.176	
	Keyboard LITE-ON SK-9611 PS/2 Black Norwegian with new acer logo	KB.PS20B.177	
	Keyboard LITE-ON SK-9611 PS/2 Black Hebrew with new acer logo	KB.PS20B.178	
	Keyboard LITE-ON SK-9611 PS/2 Black Polish with new acer logo	KB.PS20B.179	

Category	Part Number	Acer P/N	Exploded Diagram Item
	Keyboard LITE-ON SK-9611 PS/2 Black Slovenian with new acer logo	KB.PS20B.180	
	Keyboard LITE-ON SK-9611 PS/2 Black Slovak with new acer logo	KB.PS20B.181	
	Keyboard LITE-ON SK-9611 PS/2 Black Russian with new acer logo	KB.PS20B.182	
	Keyboard LITE-ON SK-9611 PS/2 Black Hungarian with new acer logo	KB.PS20B.183	
	Keyboard LITE-ON SK-9611 PS/2 Black Greek with new acer logo	KB.PS20B.184	
	Keyboard LITE-ON SK-9611 PS/2 Black Danish with new acer logo	KB.PS20B.185	
	Keyboard LITE-ON SK-9611 PS/2 Black Czech with new acer logo	KB.PS20B.186	
	Keyboard LITE-ON SK-9611 PS/2 Black Romanian with new acer logo	KB.PS20B.187	
	Keyboard LITE-ON SK-9611 PS/2 Black Turkish with new acer logo	KB.PS20B.188	
	Keyboard LITE-ON SK-9611 PS/2 Black Turkish-Q with new acer logo	KB.PS20B.189	
	Keyboard LITE-ON SK-9611 PS/2 Black Arabic/French with new acer logo	KB.PS20B.190	
	Keyboard LITE-ON SK-9611 PS/2 Black Kazakh with new acer logo	KB.PS20B.191	
	Keyboard LITE-ON SK-9611 PS/2 Black Turkmen with new acer logo	KB.PS20B.192	
	Keyboard LITE-ON SK-9611 PS/2 Black Nordic with new acer logo	KB.PS20B.193	
	Keyboard LITE-ON SK-9611 PS/2 Black English/Canadian French with new acer logo	KB.PS20B.194	
	Keyboard LITE-ON SK-9611 PS/2 Black Czech/Slovak with new acer logo	KB.PS20B.195	
	Keyboard LITE-ON SK-9611 PS/2 Black Swiss/FR with new acer logo	KB.PS20B.196	
	Keyboard LITE-ON SK-9611 PS/2 Black Korean with new acer logo	KB.PS20B.197	
	Keyboard LITE-ON SK-9611 PS/2 Black Spanish Latin with new acer logo	KB.PS20B.198	
	Keyboard PRIMAX KBRF36211 RF2.4 Black US with new acer logo	KB.RF40P.144	
	Keyboard PRIMAX KBRF36211 RF2.4 Black Traditional Chinese with new acer logo	KB.RF40P.145	
	Keyboard PRIMAX KBRF36211 RF2.4 Black Simplified Chinese with new acer logo	KB.RF40P.146	

Category	Part Number	Acer P/N	Exploded Diagram Item
	Keyboard PRIMAX KBRF36211 RF2.4 Black US International with new acer logo	KB.RF40P.147	
	Keyboard PRIMAX KBRF36211 RF2.4 Black Arabic/English with new acer logo	KB.RF40P.148	
	Keyboard PRIMAX KBRF36211 RF2.4 Black Thailand with new acer logo	KB.RF40P.149	
	Keyboard PRIMAX KBRF36211 RF2.4 Black Spanish with new acer logo	KB.RF40P.150	
	Keyboard PRIMAX KBRF36211 RF2.4 Black Portuguese with new acer logo	KB.RF40P.151	
	Keyboard PRIMAX KBRF36211 RF2.4 Black Canadian French with new acer logo	KB.RF40P.152	
	Keyboard PRIMAX KBRF36211 RF2.4 Black Brazilian Portuguese with new acer logo	KB.RF40P.153	
	Keyboard PRIMAX KBRF36211 RF2.4 Black Japanese with new acer logo	KB.RF40P.154	
	Keyboard PRIMAX KBRF36211 RF2.4 Black German with new acer logo	KB.RF40P.155	
	Keyboard PRIMAX KBRF36211 RF2.4 Black Italian with new acer logo	KB.RF40P.156	
	Keyboard PRIMAX KBRF36211 RF2.4 Black French with new acer logo	KB.RF40P.157	
	Keyboard PRIMAX KBRF36211 RF2.4 Black Swedish with new acer logo	KB.RF40P.158	
	Keyboard PRIMAX KBRF36211 RF2.4 Black UK with new acer logo	KB.RF40P.159	
	Keyboard PRIMAX KBRF36211 RF2.4 Black Dutch with new acer logo	KB.RF40P.160	
	Keyboard PRIMAX KBRF36211 RF2.4 Black Swiss/G with new acer logo	KB.RF40P.161	
	Keyboard PRIMAX KBRF36211 RF2.4 Black Belgium with new acer logo	KB.RF40P.162	
	Keyboard PRIMAX KBRF36211 RF2.4 Black Icelandic with new acer logo	KB.RF40P.163	
	Keyboard PRIMAX KBRF36211 RF2.4 Black Norwegian with new acer logo	KB.RF40P.164	
	Keyboard PRIMAX KBRF36211 RF2.4 Black Hebrew with new acer logo	KB.RF40P.165	
	Keyboard PRIMAX KBRF36211 RF2.4 Black Polish with new acer logo	KB.RF40P.166	
	Keyboard PRIMAX KBRF36211 RF2.4 Black Slovenian with new acer logo	KB.RF40P.167	
	Keyboard PRIMAX KBRF36211 RF2.4 Black Slovak with new acer logo	KB.RF40P.168	

Category	Part Number	Acer P/N	Exploded Diagram Item
	Keyboard PRIMAX KBRF36211 RF2.4 Black Russian with new acer logo	KB.RF40P.169	
	Keyboard PRIMAX KBRF36211 RF2.4 Black Hungarian with new acer logo	KB.RF40P.170	
	Keyboard PRIMAX KBRF36211 RF2.4 Black Greek with new acer logo	KB.RF40P.171	
	Keyboard PRIMAX KBRF36211 RF2.4 Black Danish with new acer logo	KB.RF40P.172	
	Keyboard PRIMAX KBRF36211 RF2.4 Black Czech with new acer logo	KB.RF40P.173	
	Keyboard PRIMAX KBRF36211 RF2.4 Black Romanian with new acer logo	KB.RF40P.174	
	Keyboard PRIMAX KBRF36211 RF2.4 Black Turkish with new acer logo	KB.RF40P.175	
	Keyboard PRIMAX KBRF36211 RF2.4 Black Turkish-Q with new acer logo	KB.RF40P.176	
	Keyboard PRIMAX KBRF36211 RF2.4 Black Arabic/French with new acer logo	KB.RF40P.177	
	Keyboard PRIMAX KBRF36211 RF2.4 Black Kazakh with new acer logo	KB.RF40P.178	
	Keyboard PRIMAX KBRF36211 RF2.4 Black Turkmen with new acer logo	KB.RF40P.179	
	Keyboard PRIMAX KBRF36211 RF2.4 Black Nordic with new acer logo	KB.RF40P.180	
	Keyboard PRIMAX KBRF36211 RF2.4 Black English/Canadian French with new acer logo	KB.RF40P.181	
	Keyboard PRIMAX KBRF36211 RF2.4 Black Czech/Slovak with new acer logo	KB.RF40P.182	
	Keyboard PRIMAX KBRF36211 RF2.4 Black Swiss/FR with new acer logo	KB.RF40P.183	
	Keyboard PRIMAX KBRF36211 RF2.4 Black Korean with new acer logo	KB.RF40P.184	
	Keyboard PRIMAX KBRF36211 RF2.4 Black Spanish Latin with new acer logo	KB.RF40P.185	
	Keyboard PRIMAX KBRF36211 RF2.4 Black Spanish Latin without battery;with new acer logo	KB.RF40P.186	
	Keyboard PRIMAX KBRF36211 RF2.4 Black US with India Rupee Symbol with new acer logo	KB.RF40P.199	
	Keyboard PRIMAX KB36211 USB Black US with new acer logo	KB.USB0P.217	
	Keyboard PRIMAX KB36211 USB Black Traditional Chinese with new acer logo	KB.USB0P.218	
	Keyboard PRIMAX KB36211 USB Black Simplified Chinese with new acer logo	KB.USB0P.219	

Category	Part Number	Acer P/N	Exploded Diagram Item
	Keyboard PRIMAX KB36211 USB Black US International with new acer logo	KB.USB0P.220	
	Keyboard PRIMAX KB36211 USB Black Arabic/English with new acer logo	KB.USB0P.221	
	Keyboard PRIMAX KB36211 USB Black Thailand with new acer logo	KB.USB0P.222	
	Keyboard PRIMAX KB36211 USB Black Spanish with new acer logo	KB.USB0P.223	
	Keyboard PRIMAX KB36211 USB Black Portuguese with new acer logo	KB.USB0P.224	
	Keyboard PRIMAX KB36211 USB Black Canadian French with new acer logo	KB.USB0P.225	
	Keyboard PRIMAX KB36211 USB Black Brazilian Portuguese with new acer logo	KB.USB0P.226	
	Keyboard PRIMAX KB36211 USB Black Japanese with new acer logo	KB.USB0P.227	
	Keyboard PRIMAX KB36211 USB Black German with new acer logo	KB.USB0P.228	
	Keyboard PRIMAX KB36211 USB Black Italian with new acer logo	KB.USB0P.229	
	Keyboard PRIMAX KB36211 USB Black French with new acer logo	KB.USB0P.230	
	Keyboard PRIMAX KB36211 USB Black Swedish with new acer logo	KB.USB0P.231	
	Keyboard PRIMAX KB36211 USB Black UK with new acer logo	KB.USB0P.232	
	Keyboard PRIMAX KB36211 USB Black Dutch with new acer logo	KB.USB0P.233	
	Keyboard PRIMAX KB36211 USB Black Swiss/G with new acer logo	KB.USB0P.234	
	Keyboard PRIMAX KB36211 USB Black Belgium with new acer logo	KB.USB0P.235	
	Keyboard PRIMAX KB36211 USB Black Icelandic with new acer logo	KB.USB0P.236	
	Keyboard PRIMAX KB36211 USB Black Norwegian with new acer logo	KB.USB0P.237	
	Keyboard PRIMAX KB36211 USB Black Hebrew with new acer logo	KB.USB0P.238	
	Keyboard PRIMAX KB36211 USB Black Polish with new acer logo	KB.USB0P.239	
	Keyboard PRIMAX KB36211 USB Black Slovenian with new acer logo	KB.USB0P.240	
	Keyboard PRIMAX KB36211 USB Black Slovak with new acer logo	KB.USB0P.241	

Category	Part Number	Acer P/N	Exploded Diagram Item
	Keyboard PRIMAX KB36211 USB Black Russian with new acer logo	KB.USB0P.242	
	Keyboard PRIMAX KB36211 USB Black Hungarian with new acer logo	KB.USB0P.243	
	Keyboard PRIMAX KB36211 USB Black Greek with new acer logo	KB.USB0P.244	
	Keyboard PRIMAX KB36211 USB Black Danish with new acer logo	KB.USB0P.245	
	Keyboard PRIMAX KB36211 USB Black Czech with new acer logo	KB.USB0P.246	
	Keyboard PRIMAX KB36211 USB Black Romanian with new acer logo	KB.USB0P.247	
	Keyboard PRIMAX KB36211 USB Black Turkish with new acer logo	KB.USB0P.248	
	Keyboard PRIMAX KB36211 USB Black Turkish-Q with new acer logo	KB.USB0P.249	
	Keyboard PRIMAX KB36211 USB Black Arabic/French with new acer logo	KB.USB0P.250	
	Keyboard PRIMAX KB36211 USB Black Kazakh with new acer logo	KB.USB0P.251	
	Keyboard PRIMAX KB36211 USB Black Turkmen with new acer logo	KB.USB0P.252	
	Keyboard PRIMAX KB36211 USB Black Nordic with new acer logo	KB.USB0P.253	
	Keyboard PRIMAX KB36211 USB Black English/Canadian French with new acer logo	KB.USB0P.254	
	Keyboard PRIMAX KB36211 USB Black Czech/Slovak with new acer logo	KB.USB0P.255	
	Keyboard PRIMAX KB36211 USB Black Swiss/FR with new acer logo	KB.USB0P.256	
	Keyboard PRIMAX KB36211 USB Black Korean with new acer logo	KB.USB0P.257	
	Keyboard PRIMAX KB36211 USB Black Spanish Latin with new acer logo	KB.USB0P.258	
	Keyboard PRIMAX KB36211 USB Black US with India Rupee Symbol with new acer logo	KB.USB0P.306	
	Keyboard PRIMAX KB36111 PS/2 Black US with new acer logo	KB.PS20P.204	
	Keyboard PRIMAX KB36111 PS/2 Black Traditional Chinese with new acer logo	KB.PS20P.205	
	Keyboard PRIMAX KB36111 PS/2 Black Simplified Chinese with new acer logo	KB.PS20P.206	
	Keyboard PRIMAX KB36111 PS/2 Black US International with new acer logo	KB.PS20P.207	

Category	Part Number	Acer P/N	Exploded Diagram Item
	Keyboard PRIMAX KB36111 PS/2 Black Arabic/English with new acer logo	KB.PS20P.208	
	Keyboard PRIMAX KB36111 PS/2 Black Thailand with new acer logo	KB.PS20P.209	
	Keyboard PRIMAX KB36111 PS/2 Black Spanish with new acer logo	KB.PS20P.210	
	Keyboard PRIMAX KB36111 PS/2 Black Portuguese with new acer logo	KB.PS20P.211	
	Keyboard PRIMAX KB36111 PS/2 Black Canadian French with new acer logo	KB.PS20P.212	
	Keyboard PRIMAX KB36111 PS/2 Black Brazilian Portuguese with new acer logo	KB.PS20P.213	
	Keyboard PRIMAX KB36111 PS/2 Black Japanese with new acer logo	KB.PS20P.214	
	Keyboard PRIMAX KB36111 PS/2 Black German with new acer logo	KB.PS20P.215	
	Keyboard PRIMAX KB36111 PS/2 Black Italian with new acer logo	KB.PS20P.216	
	Keyboard PRIMAX KB36111 PS/2 Black French with new acer logo	KB.PS20P.217	
	Keyboard PRIMAX KB36111 PS/2 Black Swedish with new acer logo	KB.PS20P.218	
	Keyboard PRIMAX KB36111 PS/2 Black UK with new acer logo	KB.PS20P.219	
	Keyboard PRIMAX KB36111 PS/2 Black Dutch with new acer logo	KB.PS20P.220	
	Keyboard PRIMAX KB36111 PS/2 Black Swiss/G with new acer logo	KB.PS20P.221	
	Keyboard PRIMAX KB36111 PS/2 Black Belgium with new acer logo	KB.PS20P.222	
	Keyboard PRIMAX KB36111 PS/2 Black Icelandic with new acer logo	KB.PS20P.223	
	Keyboard PRIMAX KB36111 PS/2 Black Norwegian with new acer logo	KB.PS20P.224	
	Keyboard PRIMAX KB36111 PS/2 Black Hebrew with new acer logo	KB.PS20P.225	
	Keyboard PRIMAX KB36111 PS/2 Black Polish with new acer logo	KB.PS20P.226	
	Keyboard PRIMAX KB36111 PS/2 Black Slovenian with new acer logo	KB.PS20P.227	
	Keyboard PRIMAX KB36111 PS/2 Black Slovak with new acer logo	KB.PS20P.228	
	Keyboard PRIMAX KB36111 PS/2 Black Russian with new acer logo	KB.PS20P.229	

Category	Part Number	Acer P/N	Exploded Diagram Item
	Keyboard PRIMAX KB36111 PS/2 Black Hungarian with new acer logo	KB.PS20P.230	
	Keyboard PRIMAX KB36111 PS/2 Black Greek with new acer logo	KB.PS20P.231	
	Keyboard PRIMAX KB36111 PS/2 Black Danish with new acer logo	KB.PS20P.232	
	Keyboard PRIMAX KB36111 PS/2 Black Czech with new acer logo	KB.PS20P.233	
	Keyboard PRIMAX KB36111 PS/2 Black Romanian with new acer logo	KB.PS20P.234	
	Keyboard PRIMAX KB36111 PS/2 Black Turkish with new acer logo	KB.PS20P.235	
	Keyboard PRIMAX KB36111 PS/2 Black Turkish-Q with new acer logo	KB.PS20P.236	
	Keyboard PRIMAX KB36111 PS/2 Black Arabic/French with new acer logo	KB.PS20P.237	
	Keyboard PRIMAX KB36111 PS/2 Black Kazakh with new acer logo	KB.PS20P.238	
	Keyboard PRIMAX KB36111 PS/2 Black Turkmen with new acer logo	KB.PS20P.239	
	Keyboard PRIMAX KB36111 PS/2 Black Nordic with new acer logo	KB.PS20P.240	
	Keyboard PRIMAX KB36111 PS/2 Black English/Canadian French with new acer logo	KB.PS20P.241	
	Keyboard PRIMAX KB36111 PS/2 Black Czech/Slovak with new acer logo	KB.PS20P.242	
	Keyboard PRIMAX KB36111 PS/2 Black Swiss/FR with new acer logo	KB.PS20P.243	
	Keyboard PRIMAX KB36111 PS/2 Black Korean with new acer logo	KB.PS20P.244	
	Keyboard PRIMAX KB36111 PS/2 Black Spanish Latin with new acer logo	KB.PS20P.245	
	Keyboard PRIMAX KB36111 PS/2 Black US with India Rupee Symbol with new acer logo	KB.PS20P.290	